

**April 2019**

# The SAT<sup>®</sup>

---

# Question- and-Answer Service

---

**Use this with your QAS Student Guide  
and personalized QAS Report.**

**What's inside:**

The SAT and SAT Essay administered on your test day



NOT FOR REPRODUCTION OR RESALE.

## ABOUT COLLEGE BOARD

College Board is a mission-driven not-for-profit organization that connects students to college success and opportunity. Founded in 1900, College Board was created to expand access to higher education. Today, the membership association is made up of over 6,000 of the world's leading educational institutions and is dedicated to promoting excellence and equity in education. Each year, College Board helps more than seven million students prepare for a successful transition to college through programs and services in college readiness and college success—including the SAT® and the Advanced Placement Program®. The organization also serves the education community through research and advocacy on behalf of students, educators, and schools. For further information, visit [collegeboard.org](http://collegeboard.org).

---

## SAT CUSTOMER SERVICE

You can reach us from 8 a.m. to 9 p.m. ET (9 a.m. to 7 p.m. after the June test through August 19).

**Phone:** 866-756-7346

**International:** +1-212-713-7789

**Email:** [sat@info.collegeboard.org](mailto:sat@info.collegeboard.org)

**Mail:** College Board SAT Program, P.O. Box 025505, Miami, FL 33102

---

## TABLE OF CONTENTS

- 1 Introduction
- 2 Reading Test
- 18 Writing and Language Test
- 34 Math Test – No Calculator
- 41 Math Test – Calculator
- 56 Essay

# Introduction

Congratulations on taking the SAT®! This booklet contains the SAT you took in April 2019, including (if you took the SAT Essay) an Essay prompt you responded to. This booklet contains every question and prompt that was scored.

As part of the Question-and-Answer Service (QAS) you also have received:

1. A customized report that lists the following details about each question:
  - ▶ answer you gave
  - ▶ best or correct answer
  - ▶ question type
  - ▶ difficulty level
2. A QAS Student Guide that explains your scores and how to interpret them.

The test begins on the next page.

# Reading Test

65 MINUTES, 52 QUESTIONS

Turn to Section 1 of your answer sheet to answer the questions in this section.

## DIRECTIONS

Each passage or pair of passages below is followed by a number of questions. After reading each passage or pair, choose the best answer to each question based on what is stated or implied in the passage or passages and in any accompanying graphics (such as a table or graph).

### Questions 1-10 are based on the following passage.

This passage is adapted from Cristina Henríquez, *The Book of Unknown Americans*. ©2014 by Cristina Henríquez.

One afternoon I made chicharrones and carried them over to Celia’s apartment.

Line She clapped her hands together in delight when she saw me and motioned for me to come inside.

5 “These are for you,” I said, holding out a foil-covered plate.

She lifted a corner of the foil and sniffed. “Sabroso,” she said.

I loved how full her home felt, embroidered  
10 pillows on the couches, a curio stacked with milk glass bowls and recuerdos and folded tablecloths, red votives along the windowsills, spidery potted plants, woven rugs, unframed posters of Panamá beaches on the walls, a box of rinsed bottles on the floor, a small  
15 radio on top of the refrigerator, a plastic bag filled with garlic hanging from a doorknob, a collection of spices clustered on a platter on the counter. The great accumulation of things almost hid the cracks in the walls and the stains on the floor and the scratches  
20 that clouded the windows.

“Mi casa es tu casa,” Celia joked as I looked around. “Isn’t that what the Americans say?”

She poured cold, crackling Coca-Colas for both of us, and we sat on the couch, sipping them and taking  
25 small bites of the chicharrones. She looked just as she had the first time I met her: impeccably pulled together, with a face full of makeup, fuchsia lips, chestnut-brown chin-length hair curled at the ends

and tucked neatly behind her ears, small gold  
30 earrings. So unlike most of my friends at home, who used nothing but soap on their faces and aloe on their hands and who kept their hair pulled into ponytails, like mine, or simply combed after it had been washed and left to air-dry.

35 Celia told me about the provisions we would need for winter—heavy coats and a stack of comforters and something called long underwear that made me laugh when she tried to describe it—and about a place called the Community House where they  
40 offered immigrant services if we needed them. She gossiped about people in the building. She told me that Micho Alvarez, who she claimed always wore his camera around his neck, had a sensitive side, despite the fact that he might look big and burly, and that  
45 Benny Quinto, who was close friends with Micho, had studied to be a priest years ago. She said that Quisqueya dyed her hair, which was hardly news—I had assumed as much when I met her. “It’s the most unnatural shade of red,” Celia said. “Rafael  
50 says it looks like she dumped a pot of tomato sauce on her head.” She chortled. “Quisqueya is a busybody, but it’s only because she’s so insecure. She doesn’t know how to connect with people. Don’t let her put you off.”

55 Celia began telling me about when she and Rafael and her boys had come here from Panamá, fifteen years ago, after the invasion.

“So your son, he was born there?” I asked.

“I have two boys,” she said. “Both of them were  
60 born there. Enrique, my oldest, is away at college on  
a soccer scholarship. And there’s Mayor, who you  
met. He’s nothing at all like his brother. Rafa thinks  
we might have taken the wrong baby home from the  
hospital.” She forced a smile. “Just a joke, of course.”

65 She stood and lifted a framed picture from the  
end table. “This is from last summer before Enrique  
went back to school,” she said, handing it to me.  
“Micho took it for us.”

In the photo were two boys: Mayor, whom I  
70 recognized from the store, small for his age with  
dark, buzzed hair and sparkling eyes, and Enrique,  
who stood next to his brother with his arms crossed,  
the faint shadow of a mustache above his lip.

“What about you?” Celia asked. “Do you have  
75 other children besides your daughter?”

“Only her,” I said, glancing at my hands around  
the glass. The perspiration from the ice had left a ring  
of water on the thigh of my pants.

80 “And she’s going . . .” Celia trailed off, as though  
she didn’t want to say it out loud.

“To Evers.”

Celia nodded. She looked like she didn’t know  
what to say next, and I felt a mixture of  
embarrassment and indignation.

85 “It’s temporary,” I said. “She only has to go there  
for a year or two.”

“You don’t have to explain it to me.”

“She’s going to get better.”

“I’ve heard it’s a good school.”

90 “I hope so. It’s why we came.”

Celia gazed at me for a long time before she said,  
“When we left Panamá, it was falling apart. Rafa and  
I thought it would be better for the boys to grow up  
here. Even though Panamá was where we had spent  
95 our whole lives. It’s amazing, isn’t it, what parents  
will do for their children?”

She put her hand on mine. A benediction. From  
then, we were friends.

1

The description of Celia’s apartment in lines 9-20 is primarily intended to

- A) evoke a sense of coziness and comfort.
- B) reflect the hectic and unpredictable nature of life in Celia’s building.
- C) extol the ready availability of goods in the United States.
- D) establish that Celia is an avid collector.

2

According to the passage, which fact about Celia’s neighbors does the narrator know before she visits Celia’s apartment?

- A) Micho Alvarez and Benny Quinto are close friends.
- B) Benny Quinto once studied to be a priest.
- C) Micho Alvarez has a sensitive side.
- D) Quisqueya dyes her hair.

3

When Celia tells the narrator not to let Quisqueya “put you off” (line 54), she most nearly means that the narrator should not

- A) be offended by Quisqueya.
- B) be deceived by Quisqueya.
- C) let Quisqueya avoid her.
- D) let Quisqueya impose on her.

4

Which choice best describes the narrator’s relationship with Celia’s sons?

- A) The narrator knows Celia’s sons because they are friends with the narrator’s daughter.
- B) The narrator’s daughter attends school with Mayor.
- C) The narrator has seen Mayor in person, but she has seen Enrique only in Celia’s photo.
- D) The narrator has seen Enrique play soccer, but she has never seen Mayor.

5

Which choice provides the best evidence for the answer to the previous question?

- A) Line 58 (“So . . . asked”)
- B) Lines 59-62 (“I have . . . brother”)
- C) Lines 65-68 (“She stood . . . us”)
- D) Lines 74-75 (“What . . . daughter”)

6

Celia recounts Rafa’s joke (lines 61-64) primarily in order to

- A) endear Rafa to the narrator.
- B) impress the narrator with her quick wit.
- C) stress how different her sons are.
- D) defuse a tense situation.

7

Based on the passage, it is most reasonable to infer that Celia knows the answer to which question about the narrator’s family before the narrator visits her apartment?

- A) How many children does the narrator have?
- B) Where does the narrator’s daughter go to school?
- C) What is the narrator’s profession?
- D) How long have the narrator and her family lived in the United States?

8

Which choice provides the best evidence for the answer to the previous question?

- A) Lines 79-80 (“And . . . loud”)
- B) Lines 82-84 (“Celia . . . indignation”)
- C) Lines 92-94 (“When . . . here”)
- D) Lines 95-96 (“It’s amazing . . . children”)

9

Based on the passage, it can reasonably be inferred that Celia tells the narrator about leaving Panama (lines 91-96) primarily to

- A) encourage the narrator to share her story of immigration.
- B) remind the narrator of the reasons they both immigrated to the United States.
- C) console the narrator by describing how Celia’s family has prospered since they left.
- D) assure the narrator that she understands and empathizes with her.

10

In line 97, the word “benediction” primarily serves to

- A) stress the importance of religion to Celia and the narrator.
- B) imply that the narrator views Celia as an authority figure.
- C) emphasize how meaningful Celia’s gesture was for the narrator.
- D) demonstrate how eloquently Celia spoke during her conversation with the narrator.

**Questions 11-21 are based on the following passage and supplementary material.**

This passage is adapted from Wray Herbert, “Extremist Politics: Debating the Nuts and Bolts.” ©2012 by TheHuffingtonPost.com, Inc.

Voters need to understand the prosaic details of complex policies. Most have staked out positions on these issues, but they are not often reasoned positions, which take hard intellectual work. Most citizens opt instead for simplistic explanations, assuming wrongly that they comprehend the nuances of issues.

Psychological scientists have a name for this easy, automatic, simplistic thinking: the illusion of explanatory depth. We strongly believe that we understand complex matters, when in fact we are clueless, and these false and extreme beliefs shape our preferences, judgments, and actions—including our votes.

Is it possible to shake such deep-rooted convictions? That’s the question that Philip Fernbach, a psychological scientist at the University of Colorado’s Leeds School of Business, wanted to explore. Fernbach and his colleagues wondered if forcing people to explain complex policies in detail—not cheerleading for a position but really considering the mechanics of implementation—might force them to confront their ignorance and thus weaken their extremist stands on issues. They ran a series of lab experiments to test this idea.

They started by recruiting a group of volunteers in their 30s—Democrats, Republicans, and Independents—and asking them to state their positions on a variety of issues, from a national flat tax to a cap-and-trade system for carbon emissions. The volunteers indicated how strongly they felt about each issue and also rated their own understanding of the issues. Then the volunteers were instructed to write elaborate explanations of two issues. If the issue was cap and trade, for example, they would first explain precisely what cap and trade means, how it is implemented, whom it benefits and whom it could hurt, the sources of carbon emissions, and so forth. They were not asked for value judgments about the policy or about the environment or business, but only for a highly detailed description of the mechanics of the policy in action.

Let’s be honest: Most of us never do this.

Fernbach’s idea was that such an exercise would force many to realize just how little they really know

about cap and trade, and confronted with their own ignorance, they would dampen their own enthusiasm. They would be humbled and as a result take less extreme positions. And that’s just what happened. Trying—and failing—to explain complex policies undermined the extremists’ illusions about being well-informed. They became more moderate in their views as a result.

Being forced to articulate the nuts and bolts of a policy is not the same as trying to sell that policy. In fact, talking about one’s views can often strengthen them. Fernbach believes it’s the slow, cognitive work—the deliberate analysis—that changes people’s judgments, but he wanted to check this in another experiment. This one was very similar to the first, but some volunteers, instead of explaining a policy, merely listed reasons for liking it.

The results were clear. Those who simply listed reasons for their positions—articulating their values—were less shaken in their views. They continued to think they understood the policies in their complexity, and, notably, they remained extreme in their passion for their positions.

Polarization tends to reinforce itself. People are unaware of their own ignorance, and they seek out information that bolsters their views, often without knowing it. They also process new information in biased ways, and they hang out with people like themselves. All of these psychological forces increase political extremism, and no simple measure will change that. But forcing the candidates to provide concrete and elaborate plans might be a start; it gives citizens a starting place.

**Figure 1**

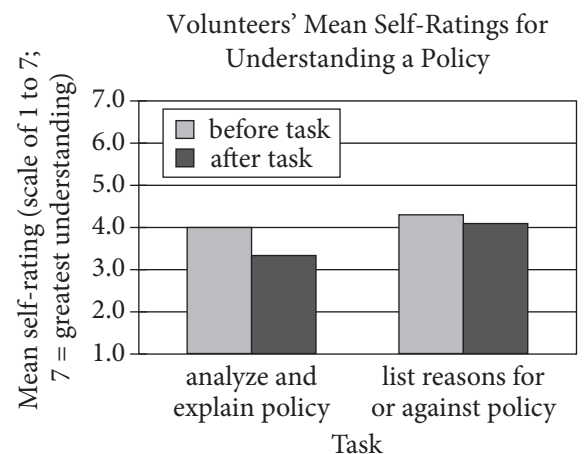

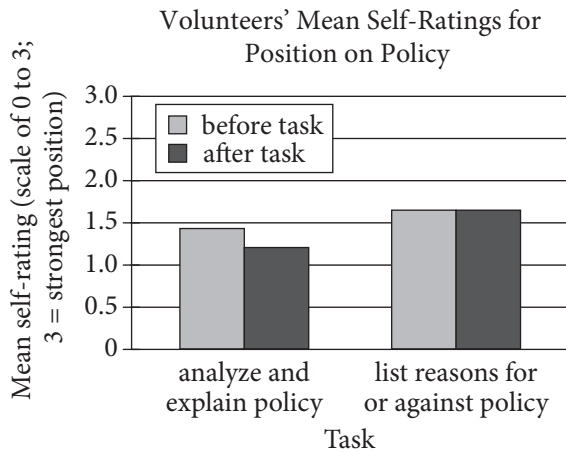
**Figure 2**

Figures adapted from Philip Fernbach et al., "Political Extremism Is Supported by an Illusion of Understanding." ©2013 by Philip Fernbach et al.

**11**

A central idea discussed in the passage is that

- A) articulating the reasons for holding an opinion can cause people to decide that they are wrong.
- B) the process of describing an issue in detail can make people more moderate in their views about the issue.
- C) most people are not truly interested in understanding complex ideas.
- D) people are likely to understate their most passionately held positions to avoid offending others.

**12**

Over the course of the passage, the main focus shifts from

- A) a discussion of a long-standing problem, to a report that discredits previous attempts to address that problem, and then to a proposal for future action.
- B) an introduction of a phenomenon, to a description of experiments concerning that phenomenon, and then to a recommendation based on the results of the experiments.
- C) an explanation of two competing theories for a certain behavior, to a recap of a study designed to determine which theory is correct, and then to a general account of a field's future.
- D) an observation of a trend, to an analysis of its causes, and then to a proposal for a research study to validate the analysis.

**13**

As used in line 9, "illusion" most nearly means

- A) misconception.
- B) dream.
- C) charade.
- D) phantom.

**14**

As used in line 13, "shape" most nearly means

- A) plan.
- B) model.
- C) influence.
- D) modify.



15

The main purpose of the fourth paragraph (lines 26-42) is to

- A) provide support for a theory.
- B) defend the need for a research study.
- C) outline the specifics of an experiment.
- D) discuss the complexity of a particular issue.

16

The passage implies that when conducting his laboratory work, Fernbach would have been most surprised by which finding?

- A) No link was found between the complexity of an issue and the strength of the volunteers' positions.
- B) After volunteers were asked to analyze a complicated political issue, their understanding of it did not increase.
- C) When volunteers were asked to list their reasons for endorsing a particular policy, their views were generally unaffected by the exercise.
- D) When volunteers were asked questions about complex issues, those with the most extreme views were found to have the best overall understanding of them.

17

Which choice provides the best evidence for the answer to the previous question?

- A) Lines 26-30 ("They started . . . emissions")
- B) Lines 34-38 ("If the . . . forth")
- C) Lines 39-42 ("They . . . action")
- D) Lines 44-49 ("Fernbach's . . . positions")

18

Based on the passage, which action would most likely reduce political extremism among the citizenry?

- A) Forming organized groups of people who share their most deeply held convictions
- B) Requiring that politicians explain their proposed policies in detail before an election is held
- C) Promoting awareness of charities that provide opportunities to donate money to worthy but underfunded causes
- D) Hosting events that encourage people who hold opposing points of view to interact with one another

19

Which choice provides the best evidence for the answer to the previous question?

- A) Lines 65-68 ("They continued . . . positions")
- B) Lines 69-72 ("People . . . knowing it")
- C) Lines 72-74 ("They . . . themselves")
- D) Lines 76-78 ("But forcing . . . place")

20

According to figure 1, which statement best describes the change in the mean self-ratings of the volunteers after they were asked to analyze and explain a policy?

- A) They became more extreme in their position on the policy.
- B) They became more reluctant to justify a particular viewpoint.
- C) They became less confident in their understanding of the policy.
- D) They became less interested in the policy.

21

According to both the passage and figure 2, making a list of reasons for or against a policy has little impact on an individual's

- A) position on an issue.
- B) interest in an issue.
- C) opinion about people holding differing views.
- D) likelihood to vote in an election.

**Questions 22-32 are based on the following passage and supplementary material.**

This passage is adapted from "Rare Woodland Plant Uses 'Cryptic Coloration' to Hide from Predators." ©2009 by American Journal of Botany, Inc.

It is well known that some animal species use camouflage to hide from predators. Individuals that are able to blend in to their surroundings and avoid being eaten are able to survive longer, reproduce, and thus increase their fitness (pass along their genes to the next generation) compared to those who stand out more. This may seem like a good strategy, and fairly common in the animal kingdom, but who ever heard of a plant doing the same thing?

In plants, the use of coloration or pigmentation as a vital component of acquiring food (e.g., photosynthesis) or as a means of attracting pollinators (e.g., flowers) has been well studied. However, variation in pigmentation as a means of escaping predation has received little attention. Matthew Klooster from Harvard University and colleagues empirically investigated whether the dried bracts (specialized leaves) on a rare woodland plant, *Monotropsis odorata*, might serve a similar purpose as the stripes on a tiger or the grey coloration of the wings of the peppered moth: namely, to hide.

"*Monotropsis odorata* is a fascinating plant species, as it relies exclusively upon mycorrhizal fungus, that associates with its roots, for all of the resources it needs to live," notes Klooster. "Because this plant no longer requires photosynthetic pigmentation (i.e., green coloration) to produce its own energy, it is free to adopt a broader range of possibilities in coloration, much like fungi or animals."

Using a large population of *Monotropsis odorata*, Klooster and colleagues experimentally removed the dried bracts that cover the 3- to 5-cm tall stems and flower buds of these woodland plants. The bracts are a brown color that resembles the leaf litter from which the reproductive stems emerge and cover the pinkish-purple colored buds and deep purple stems. When Klooster and colleagues measured the reflectance pattern (the percentage of light reflected at various wavelengths) of the different plant parts, they indeed found that the bracts functioned as camouflage, making the plant blend in with its surroundings; the bract reflectance pattern closely resembled that of the leaf litter, and both differed from that of the reproductive stem and flowers

hidden underneath the bracts. Furthermore, they experimentally demonstrated that this camouflage actually worked to hide the plant from its predators and increased its fitness. Individuals with intact

50 bracts suffered only a quarter of the herbivore damage and produced a higher percentage of mature fruits compared to those whose bracts were removed.

“It has long been shown that animals use cryptic coloration (camouflage) as a defense mechanism to  
55 visually match a component of their natural environment, which facilitates predator avoidance,” Klooster said. “We have now experimentally demonstrated that plants have evolved a similar strategy to avoid their herbivores.”

60 Drying its bracts early to hide its reproductive parts is a good strategy when the stems are exposed to predators for long periods of time: all the other species in the subfamily Monotropeoideae have colorful fleshy bracts and are reproductively active  
65 for only a quarter of the length of time. Somewhat paradoxically, however, *Monotropsis odorata* actually relies on animals for pollination and seed dispersal. How does it accomplish this when it is disguised as dead leaf material and is able to hide so well? The  
70 authors hypothesize that the flowers emit highly fragrant odors that serve to attract pollinators and seed dispersal agents; indeed they observed bumble bees finding and pollinating many reproductive stems that were entirely hidden by the leaf litter itself.

**Figure 1**

Reflectance Patterns of Leaf Litter and *Monotropsis odorata* Structures

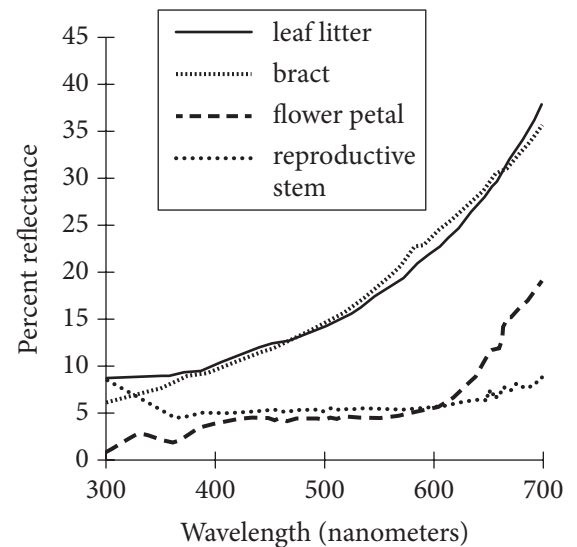

**Figure 2**

Floral Herbivore Damage to *Monotropsis odorata* Plants, 2006–2007

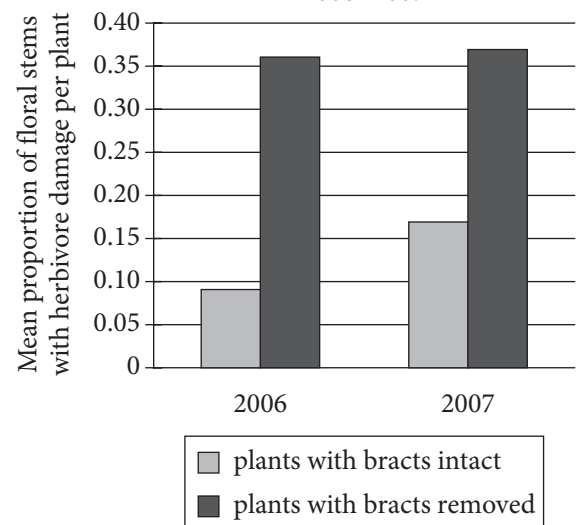

Figures adapted from Matthew R. Klooster et al., “Cryptic Bracts Facilitate Herbivore Avoidance in the Mycoheterotrophic Plant *Monotropsis odorata*.” ©2009 by American Journal of Botany, Inc.

22

The main purpose of the passage is to

- A) contrast the activities of plant species that rely on photosynthesis with the activities of those that do not.
- B) explore the attempts of scientists to understand the means by which plants attract pollinators.
- C) describe a study illuminating a defensive strategy of a particular species of plant.
- D) explain the results of experiments comparing the function of color in plants and in animals.

23

Which choice best supports the idea that the ability of a species to use camouflage effectively can provide an evolutionary advantage?

- A) Lines 1-2 (“It is . . . predators”)
- B) Lines 2-7 (“Individuals . . . more”)
- C) Lines 7-9 (“This . . . thing”)
- D) Lines 10-13 (“In plants . . . studied”)

24

The passage indicates that compared with other functions of coloration in plants, camouflage in plants has

- A) provided scientists with a deeper understanding of potential food sources.
- B) made use of a wider variety of distinctive shades of colors.
- C) proved to be a less effective defense against predators.
- D) been the subject of a smaller number of scientific investigations.

25

In lines 20-21, the references to the tiger and the moth serve mainly to

- A) provide examples of animal species with characteristics analogous to those of the plant investigated in the passage.
- B) offer a contrast between the defensive strategies of animals and the strategies of the plant examined in the passage.
- C) suggest a new possibility for applying the plant research discussed in the passage to the animal world.
- D) defend the work described in the passage against those who had criticized the inclusion of certain animals in the interpretation of the findings.

26

It can most reasonably be inferred from the passage that the nutrient requirements of many plants have the consequence of

- A) exaggerating the plants’ coloration patterns.
- B) limiting the plants’ defensive options.
- C) increasing the plants’ energy consumption.
- D) narrowing the plants’ potential habitats.

27

Which choice provides the best evidence for the answer to the previous question?

- A) Lines 16-21 (“Matthew . . . hide”)
- B) Lines 22-25 (“*Monotropis* . . . Klooster”)
- C) Lines 25-30 (“Because . . . animals”)
- D) Lines 31-34 (“Using . . . plants”)

28

As used in line 28, “broader” most nearly means more

- A) extensive.
- B) obvious.
- C) tolerant.
- D) spacious.

29

As used in line 48, “worked” most nearly means

- A) changed.
- B) influenced.
- C) functioned.
- D) manipulated.

30

According to figure 1, the percent reflectance of the flower petal of the *Monotropsis odorata* plants for light at a wavelength of 600 nanometers was approximately

- A) 5 percent.
- B) 10 percent.
- C) 20 percent.
- D) 30 percent.

31

Which statement about reflectance patterns in *Monotropsis odorata* is best supported by the data presented in figure 1?

- A) The flower petal reflectance pattern tracks closely with the bract reflectance pattern.
- B) The leaf litter reflectance pattern shows decreases in relation to increases in the flower petal reflectance pattern.
- C) The reproductive stem reflectance pattern is most similar to the leaf litter reflectance pattern.
- D) The bract reflectance pattern differs substantially from the reproductive stem reflectance pattern.

32

According to figure 2, the mean proportion of floral stems with herbivore damage per plant for *Monotropsis odorata* plants with intact bracts in 2007 was about

- A) 0.09.
- B) 0.17.
- C) 0.36.
- D) 0.40.

**Questions 33-42 are based on the following passage.**

This passage is adapted from Edmund Burke, *Reflections on the Revolution in France*. Originally published in 1790. Edmund Burke was a British politician and scholar. In 1789, the French formed a new governmental body known as the National Assembly, ushering in the tumultuous period of political and social change known as the French Revolution.

To make a government requires no great  
prudence. Settle the seat of power, teach obedience,  
and the work is done. To give freedom is still more  
Line easy. It is not necessary to guide; it only requires to  
5 let go the rein. But to form a free government, that is,  
to temper together these opposite elements of liberty  
and restraint in one consistent work, requires much  
thought, deep reflection, a sagacious, powerful, and  
combining mind. This I do not find in those who  
10 take the lead in the National Assembly. Perhaps they  
are not so miserably deficient as they appear. I rather  
believe it. It would put them below the common level  
of human understanding. But when the leaders  
choose to make themselves bidders at an auction of  
15 popularity, their talents, in the construction of the  
state, will be of no service. They will become  
flatterers instead of legislators, the instruments, not  
the guides, of the people. If any of them should  
happen to propose a scheme of liberty, soberly  
20 limited and defined with proper qualifications, he  
will be immediately outbid by his competitors who  
will produce something more splendidly popular.  
Suspensions will be raised of his fidelity to his cause.  
Moderation will be stigmatized as the virtue of  
25 cowards, and compromise as the prudence of  
traitors, until, in hopes of preserving the credit which  
may enable him to temper and moderate, on some  
occasions, the popular leader is obliged to become  
active in propagating doctrines and establishing  
30 powers that will afterwards defeat any sober purpose  
at which he ultimately might have aimed.

But am I so unreasonable as to see nothing at all  
that deserves commendation in the indefatigable  
labors of this Assembly? I do not deny that, among  
35 an infinite number of acts of violence and folly, some  
good may have been done. They who destroy  
everything certainly will remove some grievance.  
They who make everything new have a chance that  
they may establish something beneficial. To give  
40 them credit for what they have done in virtue of the  
authority they have usurped, or which can excuse  
them in the crimes by which that authority has been

acquired, it must appear that the same things could  
not have been accomplished without producing such  
45 a revolution. Most assuredly they might. . . . Some  
usages have been abolished on just grounds, but  
they were such that if they had stood as they were to  
all eternity, they would little detract from the  
happiness and prosperity of any state. The  
50 improvements of the National Assembly are  
superficial, their errors fundamental.

Whatever they are, I wish my countrymen rather  
to recommend to our neighbors the example of the  
British constitution than to take models from them  
55 for the improvement of our own. In the former, they  
have got an invaluable treasure. They are not, I think,  
without some causes of apprehension and complaint,  
but these they do not owe to their constitution but to  
their own conduct. I think our happy situation owing  
60 to our constitution, but owing to the whole of it, and  
not to any part singly, owing in a great measure to  
what we have left standing in our several reviews and  
reforms as well as to what we have altered or  
superadded. Our people will find employment  
65 enough for a truly patriotic, free, and independent  
spirit in guarding what they possess from violation. I  
would not exclude alteration neither, but even when  
I changed, it should be to preserve. I should be led to  
my remedy by a great grievance. In what I did, I  
70 should follow the example of our ancestors. I would  
make the reparation as nearly as possible in the style  
of the building. A politic caution, a guarded  
circumspection, a moral rather than a complexional  
timidity were among the ruling principles of our  
75 forefathers in their most decided conduct. Not being  
illuminated with the light of which the gentlemen of  
France tell us they have got so abundant a share, they  
acted under a strong impression of the ignorance and  
fallibility of mankind. He that had made them thus  
80 fallible rewarded them for having in their conduct  
attended to their nature. Let us imitate their caution  
if we wish to deserve their fortune or to retain their  
bequests. Let us add, if we please, but let us preserve  
what they have left; and, standing on the firm ground  
85 of the British constitution, let us be satisfied to  
admire rather than attempt to follow in their  
desperate flights the aeronauts of France.

33

It can reasonably be inferred from the passage that Burke is particularly upset with the National Assembly's decision to

- A) limit the king's power.
- B) expand the size of the government.
- C) seek the approval of the public.
- D) ignore the advice of former leaders.

34

Which choice provides the best evidence for the answer to the previous question?

- A) Lines 5-10 ("But . . . Assembly")
- B) Lines 10-13 ("Perhaps . . . understanding")
- C) Lines 13-18 ("But . . . people")
- D) Lines 49-51 ("The improvements . . . fundamental")

35

As used in line 17, "instruments" most nearly means

- A) representatives.
- B) tools.
- C) counselors.
- D) navigators.

36

Based on the passage, Burke believes that French leaders who would advocate moderate positions are

- A) brave, but are likely to be distrusted.
- B) cowardly, but are likely to be praised.
- C) virtuous, but are likely to be ignored.
- D) sensible, but are likely to be undermined.

37

As used in line 30, "sober" most nearly means

- A) grave.
- B) rehabilitated.
- C) unpretentious.
- D) reasonable.

38

Burke's central claim in the last paragraph is that the British have

- A) failed to take effective measures to safeguard their rights.
- B) acted wisely to revise rather than replace their political system.
- C) tried to export their form of government to their neighbors.
- D) left their government essentially unchanged for hundreds of years.

39

Burke refers to the repair of a building (lines 70-72) to make the point that

- A) governments need to be changed periodically to remain relevant.
- B) if a government has fundamental errors, it should be replaced.
- C) all governments have flaws that may be corrected with the proper intervention.
- D) changes to a government should maintain that government's essential properties.

40

In the passage, Burke displays the greatest respect for which of the following?

- A) The British voting public
- B) British leaders of past generations
- C) British citizens who are inspired by the French
- D) The leaders of France’s former government

41

Which choice provides the best evidence for the answer to the previous question?

- A) Lines 52-56 (“Whatever . . . treasure”)
- B) Lines 56-59 (“They are not . . . conduct”)
- C) Lines 64-67 (“Our people . . . neither”)
- D) Lines 81-84 (“Let us imitate . . . have left”)

42

Burke’s attitude toward the “gentlemen of France” (lines 76-77) would best be described as

- A) scornful.
- B) sympathetic.
- C) envious.
- D) apprehensive.

**Questions 43-52 are based on the following passages.**

Passage 1 is adapted from Rex Dalton, “Blast in the Past?” ©2007 by Nature Publishing Group. Passage 2 is adapted from Michael Balter, “What Caused a 1300-Year Deep Freeze?” ©2014 by American Association for the Advancement of Science. Clovis hunters are widely regarded as among the first people to inhabit North America.

**Passage 1**

At the 2007 American Geophysical Union’s meeting in Acapulco, Mexico, some two dozen scientists presented multiple studies arguing that a comet or asteroid exploded above or on the northern  
 Line 5 ice cap almost 13,000 years ago—showering debris across the North American continent and causing temperatures to plunge for the next millennium.

The team argues that its idea explains multiple observations: not only the climate cooling and the  
 10 disappearance of the Clovis hunters, but also the near-simultaneous extinction of the continent’s large mammals.

Not all will be convinced. Several leading hypotheses already explain each of these three events.  
 15 A change in ocean circulation is generally thought to have brought about the onset of the millennium-long cooling, which is known as the Younger Dryas. This cooling might, in turn, have caused the Clovis hunters to disappear. And, if they had not previously  
 20 been killed by disease or hunted to extinction, the big prehistoric beasts may also have been doomed by this change in climate.

The new evidence comes in the form of geochemical analysis of sedimentary layers at 25  
 25 archaeological sites across North America—9 of them Clovis. Certain features of the layers, say the team, suggest that they contain debris formed by an extraterrestrial impact. These include spherules of glass and carbon, and amounts of the element  
 30 iridium said to be too high to have originated on Earth. In addition, the rocks contain black layers of carbonized material, which the team says are the remains of wildfires that swept across the continent after the impact.

**Passage 2**

35 Proponents of the Younger Dryas impact hypothesis have claimed various kinds of evidence for the hypothesis, including deposits of the element iridium (rare on Earth but abundant in meteorites), microscopic diamonds (called nanodiamonds), and



40 magnetic particles in deposits at sites supposedly dated to about 12,800 years ago. These claims were sharply contested by some specialists in the relevant fields, however, who either did not detect such evidence or argued that the deposits had other causes  
45 than a cosmic impact. For example, some say that nanodiamonds are common in ordinary geological formations, and that magnetic particles could come from ordinary fires.

Now comes what some researchers consider the  
50 strongest attack yet on the Younger Dryas impact hypothesis. In a paper published recently in the *Proceedings of the National Academy of Sciences*, a team led by David Meltzer, an archaeologist at Southern Methodist University, Dallas, in Texas,  
55 looks at the dating of 29 different sites in the Americas, Europe, and the Middle East in which impact advocates have reported evidence for a cosmic collision. They include sites in which sophisticated stone projectiles called Clovis points,  
60 used by some of the earliest Americans to hunt mammals beginning about 13,000 years ago, have been found. The team argues that when the quality and accuracy of the dating—which was based on radiocarbon and other techniques—is examined  
65 closely, only three of the 29 sites actually fall within the time frame of the Younger Dryas onset, about 12,800 years ago; the rest were probably either earlier or later by hundreds (and in one case, thousands) of years.

70 “The supposed Younger Dryas impact fails on both theoretical and empirical grounds,” says Meltzer, who adds that the popular appeal of the hypothesis is probably due to the way that it provides “simple explanations for complex problems.” Thus,  
75 “giant chunks of space debris clobbering the planet and wiping out life on Earth has undeniably broad appeal,” Meltzer says, whereas “no one in Hollywood makes movies” about more nuanced explanations, such as Clovis points disappearing because early  
80 Americans turned to other forms of stone tool technology as the large mammals they were hunting went extinct as a result of the changing climate or hunting pressure.

But impact proponents appear unmoved by the  
85 new study. “We still stand fully behind the [impact hypothesis], which is based on more than a confluence of dates,” says Richard Firestone, a nuclear chemist at the Lawrence Berkeley National Laboratory in California. “Radiocarbon dating is a

90 perilous process,” he contends, adding that the presence of Clovis artifacts and mammoth bones just under the claimed iridium, nanodiamond, and magnetic sphere deposits is a more reliable indicator that an extraterrestrial event was responsible for their  
95 disappearance.

43

Which choice provides the best support for the claim that the impact hypothesis is not the only possible explanation for the sudden change in Earth’s climate?

- A) Lines 8-12 (“The team . . . mammals”)
- B) Lines 15-17 (“A change . . . Dryas”)
- C) Lines 23-26 (“The new . . . Clovis”)
- D) Lines 26-28 (“Certain . . . impact”)

44

Based on Passage 1, which hypothetical discovery would provide the most support for the impact hypothesis?

- A) An asteroid impact crater beneath the northern ice cap contains high levels of iridium and has been dated to well after the start of the Younger Dryas.
- B) Glass and carbon spherules appear at multiple points in the geologic record but never in conjunction with iridium deposits.
- C) Analysis of ice cores suggests that global temperatures started declining approximately 13,000 years before the onset of the Younger Dryas.
- D) High levels of osmium, which is rare on Earth but relatively common in asteroids, are observed in the geologic record from approximately 13,000 years ago.

45

According to Passage 1, the team of scientists believes that the black carbonized material found in certain sedimentary layers was caused by which phenomenon following a cosmic collision?

- A) Climate cooling
- B) Mass extinctions
- C) Rapidly spreading fires
- D) Iridium deposits

46

As used in line 42, “sharply” most nearly means

- A) suddenly.
- B) promptly.
- C) strongly.
- D) deliberately.

47

Based on Passage 2, Meltzer and his team relied on what evidence to challenge the Younger Dryas impact hypothesis?

- A) A reevaluation of the dates assigned to sites thought to display signs of the proposed impact
- B) The discovery of additional Clovis artifacts in a host of sites besides the 29 initially identified
- C) Analyses showing that nanodiamonds can occur in geologic formations lacking indications of extraterrestrial impacts
- D) High concentrations of iridium that have been found in sedimentary layers beneath the proposed impact layer

48

Which choice provides the best evidence for the answer to the previous question?

- A) Lines 35-41 (“Proponents . . . ago”)
- B) Lines 41-45 (“These . . . impact”)
- C) Lines 45-48 (“For example . . . fires”)
- D) Lines 62-69 (“The team . . . years”)

49

The phrase “more nuanced” (line 78) contrasts most directly with which word in Meltzer’s quoted remarks in lines 70-77?

- A) “theoretical”
- B) “simple”
- C) “complex”
- D) “broad”

50

Which statement best describes the relationship between the two passages?

- A) Passage 2 presents a critique of the central hypothesis described in Passage 1.
- B) Passage 2 explains the scientific question addressed by the central hypothesis developed in Passage 1.
- C) Passage 2 discusses possible implications of the central hypothesis summarized in Passage 1.
- D) Passage 2 identifies evidence in favor of the central hypothesis advanced in Passage 1.

51

The authors of both passages characterize the impact hypothesis as

- A) unsupported by reliable evidence.
- B) interesting but difficult to conclusively evaluate.
- C) more appealing to the public than to specialists.
- D) controversial in the scientific community.

52

If Meltzer's findings (Passage 2) are accurate, what can most reasonably be inferred about the glass and carbon spherules mentioned in the last paragraph of Passage 1?

- A) They could have been formed at a time other than the beginning of the Younger Dryas.
- B) They are a product of the global cooling that occurred during the Younger Dryas period.
- C) They were found in highest concentrations at Clovis archaeological sites.
- D) They may have played some role in the tool technology of the Clovis people.

**STOP**

**If you finish before time is called, you may check your work on this section only.  
Do not turn to any other section.**

# Writing and Language Test

35 MINUTES, 44 QUESTIONS

Turn to Section 2 of your answer sheet to answer the questions in this section.

## DIRECTIONS

Each passage below is accompanied by a number of questions. For some questions, you will consider how the passage might be revised to improve the expression of ideas. For other questions, you will consider how the passage might be edited to correct errors in sentence structure, usage, or punctuation. A passage or a question may be accompanied by one or more graphics (such as a table or graph) that you will consider as you make revising and editing decisions.

Some questions will direct you to an underlined portion of a passage. Other questions will direct you to a location in a passage or ask you to think about the passage as a whole.

After reading each passage, choose the answer to each question that most effectively improves the quality of writing in the passage or that makes the passage conform to the conventions of standard written English. Many questions include a “NO CHANGE” option. Choose that option if you think the best choice is to leave the relevant portion of the passage as it is.

Questions 1-11 are based on the following passage.

### Out of Many, One Experience

On June 20, 1965, murmurs of excitement filled a Kingston, Jamaica, auditorium, where **1** way more people than were expected gathered for commencement

1

Which choice helps establish the tone and style of the passage?

- A) NO CHANGE
- B) an unusually large crowd
- C) a whole bunch of unexpected people
- D) an enormous crowd of an unparalleled nature

services at the University of the West Indies. **2** Along with the 400 graduates, many people had come to hear the words of that year’s commencement speaker, the Reverend Dr. Martin Luther King Jr. **3** Furthermore, the Jamaican audience was familiar with Dr. King’s ongoing campaign for civil rights in the United States through newspaper reports and television broadcasts, and the effect of seeing Dr. King ascend to the podium just feet away from where they stood was thrilling. The day’s **4** preceding not only inspired the audience but also furthered Dr. King’s aim of enhancing solidarity between the two countries.

2

At this point, the writer is considering adding the following sentence.

The university was established by royal charter in 1948.

Should the writer make this addition here?

- A) Yes, because it provides necessary historical context that sets up the passage’s narrative.
- B) Yes, because it clarifies that commencement ceremonies were relatively new at the University of the West Indies.
- C) No, because it needlessly interrupts the discussion of Dr. King’s visit with an irrelevant detail.
- D) No, because it merely repeats information about the University of the West Indies that is given elsewhere in the passage.

3

- A) NO CHANGE
- B) As a result,
- C) By contrast,
- D) DELETE the underlined portion, adjusting the capitalization as needed.

4

- A) NO CHANGE
- B) precedents
- C) proceedings
- D) procedures

Without even consulting **5** notes, Dr. King began to speak passionately about challenges common to Jamaica and the United States. At the time, both countries were on the cusp of great change. Jamaica, **6** which would have achieved independence from Great Britain less than three years earlier, was in the process of forming a **7** government. For both countries, the quest for political and social rights was laden with setbacks. Fixing his gaze on the graduating seniors, Dr. King declared that the present generation must recognize that “no nation can live alone: we are all interdependent.” He emphasized the need for a spirit of love and worldwide brotherhood **8** from facing the challenges of the future. For Dr. King, Jamaica’s newly minted national motto—“Out of Many, One People”—perfectly encapsulated this precept of unity.

5

- A) NO CHANGE
- B) notes;
- C) notes—
- D) notes.

6

- A) NO CHANGE
- B) which achieves
- C) which will have achieved
- D) having achieved

7

The writer is considering revising the underlined portion to the following.

government; the United States, meanwhile, was on the path to expanding civil rights for its citizens.

Should the writer make this revision?

- A) Yes, because it explains why the audience felt a strong connection to Dr. King’s words.
- B) Yes, because it provides support for the claim made in the previous sentence.
- C) No, because it does not follow logically from the first part of the sentence.
- D) No, because it interrupts the paragraph’s focus on Jamaican independence.

8

- A) NO CHANGE
- B) for the facing of
- C) in facing
- D) through facing

**9** Dr. King spoke about unity that day. He also inspired unity. Years later, when asked by reporters what they remembered most, many audience members cited the same moment in the speech. They all recalled that Dr. King had said, “If it falls to our luck to be street-sweepers, sweep the streets like Raphael painted pictures, like Michelangelo carved marble. . . . Sweep the streets so well that all the hosts of heaven and earth would have to pause and say, ‘Here lived a great street sweeper.’” For **10** people, building a new nation, these words were particularly meaningful. Everyone’s efforts had great worth; everyone had an important role to play.

The experience had a profound effect not only on **11** historians but also on Dr. King, who returned to Jamaica two years later when he needed a place to write his next book. In that work, *Where Do We Go from Here: Chaos or Community?*, Dr. King envisions a world in which all people are united, a world in which the communal spirit he found in Jamaica has been embraced by all nations.

9

Which choice most effectively combines the underlined sentences?

- A) Dr. King spoke about unity by inspiring it that day.
- B) Though speaking about unity that day, Dr. King actually inspired it.
- C) Speaking about unity, however, Dr. King also inspired it.
- D) Dr. King did not just speak about unity that day: he inspired it.

10

- A) NO CHANGE
- B) people building
- C) people building,
- D) people; building

11

Which choice provides the best transition from the discussion in the previous paragraph?

- A) NO CHANGE
- B) reporters
- C) the audience
- D) those who spoke with him

Questions 12-22 are based on the following passage.

### The Theater Duke

When Georg II—duke of a small German principality called **12** Saxe-Meiningen established—a local theater in 1866, he oversaw every aspect of each production. **13** This high degree of involvement was unusual: while many principalities had court theaters, a duke would usually appoint a director to oversee the plays. Georg not only supervised the plays but also exercised full artistic control over them. Directors at the time exerted little creative influence, giving actors free rein and reusing generic stage sets. In contrast, Georg advised actors, designed elaborate sets, and choreographed scenes, contributing to the development of greater stage realism and ultimately helping to establish the role of the modern director.

**14** Georg had recruited several little-known actors when the theater company visited Berlin to perform Shakespeare’s *Julius Caesar*, captivating the metropolitan audience. When the curtain rose at 7 p.m. on May 1, 1874, the audience was immediately amazed by the

**15** productions’ elaborate sets and costumes, which Georg had modeled after Roman originals. Columns and

**12**

- A) NO CHANGE
- B) Saxe-Meiningen—established
- C) Saxe-Meiningen, established
- D) Saxe-Meiningen established

**13**

Which choice most effectively sets up the information that follows in the sentence?

- A) NO CHANGE
- B) Georg had been interested in the arts from a young age:
- C) At the time, Saxe-Meiningen was not a major cultural center:
- D) The duke maintained one of the best orchestras in Europe as well as an opera company:

**14**

Which choice provides the best transition from the previous paragraph?

- A) NO CHANGE
- B) It was the beginning of May
- C) Georg had to implement many staging changes
- D) Georg’s work as a director was on full display

**15**

- A) NO CHANGE
- B) productions elaborate sets
- C) production’s elaborate sets’
- D) production’s elaborate sets



decorative sculptures occupied the foreground of the **16** stage. As audience members marveled at the authentic-looking scenery, actors portraying Roman citizens streamed onto the stage, each bedecked in distinctive clothing, footwear, and **17** with headdresses. A trumpet then signaled the entrance of **18** Caesar. His glittering toga and armor made him instantly distinguishable. The audience members were so delighted that they broke into applause before a word was even uttered. “I could have believed myself back in ancient Rome,” one audience member said afterward.

16

The writer is considering revising the underlined portion to the following.

stage, while a backdrop painted with images of columns and fig trees provided the optical illusion of depth.

Should the writer make this revision?

- A) Yes, because it supports the claim in the previous sentence that the sets were modeled on Roman originals.
- B) Yes, because it further illustrates the spectacle that impressed audience members.
- C) No, because it unnecessarily repeats information about the columns already mentioned in the sentence.
- D) No, because it fails to provide a sufficient amount of detail about the backdrop.

17

- A) NO CHANGE
- B) wearing headdresses.
- C) in headdresses.
- D) headdresses.

18

Which choice most effectively combines the sentences at the underlined portion?

- A) Caesar: it was his glittering toga and armor that made him instantly distinguishable.
- B) Caesar being instantly distinguishable because of his glittering toga and armor.
- C) Caesar, who was instantly distinguishable by his glittering toga and armor.
- D) Caesar; instantly, his glittering toga and armor became distinguishable.

19 The venue Georg's company used was quite different from those used in Shakespeare's time. For example, he set the stage for the climactic murder of Caesar by arranging the crowd of conspiring Romans in a circle surrounding Caesar, thereby suggesting the inescapability of the ruler's fate. He also carefully orchestrated the chaotic moments following the murder, when the crowd spins out of control. Georg split the crowd into smaller 20 units, he assigned individual dialogue and stage positions, thereby making the scene more realistic.

19

- Which choice provides the best introduction to the paragraph?
- A) NO CHANGE
  - B) Some audience members were less enthusiastic about the new style.
  - C) Georg choreographed the play's action with equal intricacy.
  - D) The play emphasizes Caesar's influence over the Roman people.

20

- A) NO CHANGE
- B) units, assigning
- C) units; assigning
- D) units, and assigning

“One feels oneself present at the beginnings of a revolution,” a theater critic **21** wondered of this climactic scene; the same can perhaps be said of Georg’s achievement overall. The play was a hit, launching the duke’s group on a seventeen-year tour, during which it delivered over 2,000 performances in venues throughout Europe. Inspiring directors around the continent to design and execute more unified, detailed productions, **22** the title Georg was dubbed with was “The Theater Duke.”

21

- A) NO CHANGE
- B) presumed
- C) sensed
- D) observed

22

- A) NO CHANGE
- B) Georg’s posthumous title was “The Theater Duke.”
- C) “The Theater Duke” was a title posthumously given to Georg.
- D) Georg was posthumously dubbed “The Theater Duke.”

Questions 23-33 are based on the following passage and supplementary material.

### Free to Sing

For centuries Japanese bird enthusiasts have bred white-rumped munias, brown finches with tufts of white feathers, for **23** its plumage. Generations of this selective breeding have produced a new species: the Bengalese **24** finch; while existing only in captivity. Such breeding was intended to produce certain physical qualities in the domesticated finches, but it also had an unintended **25** consequence increased song complexity in the Bengalese finch **26** relative to that of the white-rumped munia.

23

- A) NO CHANGE
- B) one's
- C) their
- D) his or her

24

- A) NO CHANGE
- B) finch, which exists
- C) finch, it exists
- D) finch; existing

25

- A) NO CHANGE
- B) consequence: increased
- C) consequence; increased
- D) consequence. Increased

26

- A) NO CHANGE
- B) when compared with those of
- C) when compared with
- D) relative to

To explain this phenomenon, Tokyo ornithologist Kazuo Okanoya at first reasoned that finch song complexity was driven primarily by mate selection. He found that **27** female finches tend to choose males with loud, high-pitched, improvisational songs. These males are chosen over those with soft, low-pitched, predictable songs, so breeders selecting reproductively successful birds must also have selected the most dynamic singers. However, Berkeley anthropologist Terrence Deacon saw a contradiction in this idea: song complexity should occur when there is pressure to identify a mate of the same species; **28** after all, it should not occur among birds in captivity, where this pressure is lower. Deacon proposed instead that since white-rumped munias in more homogeneous groups lack pressure to find other white-rumped munias, random genetic mutations that result in song improvisation are allowed to propagate, leading to more complex songs.

To test this hypothesis, Okanoya's team tracked wild white-rumped munias in three areas in Taiwan. At each site, they **29** diagnosed flock composition (the percentage of observed flocks that were "mixed," containing white-rumped munias and another species, scaly-breasted munias) and measured the linearity of the munias' songs (a calculation based on the number of elements in a song, where 1 is simple and 0 is complex).

27

Which choice most effectively combines the sentences at the underlined portion?

- A) female finches tend to choose males with loud, high-pitched, improvisational songs over those with soft, low-pitched, predictable songs,
- B) males with loud, high-pitched, improvisational songs tend to be ones chosen by female finches over those with soft, low-pitched, predictable songs,
- C) loud, high-pitched, improvisational songs are sung by males that female finches tend to choose over those with soft, low-pitched, predictable songs,
- D) choosing males with loud, high-pitched, improvisational songs over those with soft, low-pitched, predictable songs is what female finches tend to do,

28

- A) NO CHANGE
- B) instead,
- C) therefore,
- D) similarly,

29

- A) NO CHANGE
- B) dissected
- C) traced
- D) analyzed

The linearity at the mountainous site was **30** more than 0.1 point lower than that at the urban site or the agricultural site, indicating greater song complexity. At the same time, **31** a lower percentage of flocks at the urban site were mixed than at the mountainous site. Together, these data suggest that higher song complexity is associated with greater flock uniformity.

**Figure 1**

Munia Song Linearity  
in Three Areas in Taiwan

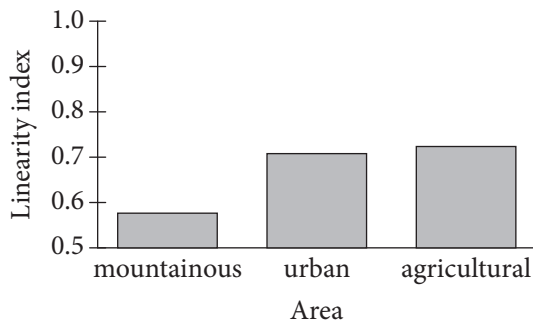

**Figure 2**

Percentage of Observed Flocks that  
Were Mixed in Three Areas in Taiwan

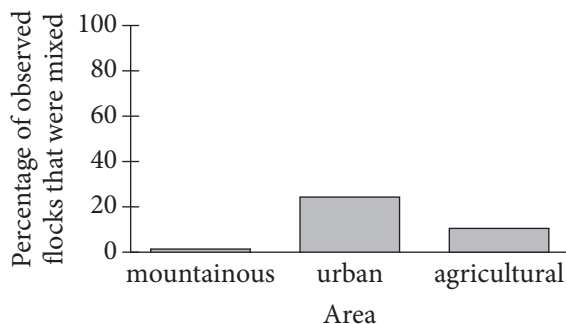

Figures adapted from Hiroko Kagawa et al., "Ecological Correlates of Song Complexity in White-Rumped Munias: The Implication of Relaxation of Selection as a Cause for Signal Variation in Birdsong." ©2012 by John Benjamins Publishing Company.

**30**

Which choice best reflects the information presented in figure 1?

- A) NO CHANGE
- B) more than 0.2 point lower than that at the urban site or
- C) about the same as that at the urban site and
- D) exactly 0.7 point higher than that at the urban site and

**31**

Which choice best reflects the data presented in figure 2?

- A) NO CHANGE
- B) a greater percentage of flocks at the urban and agricultural sites were mixed than at
- C) over 40 percent of flocks were mixed at both the urban site and
- D) the percentage of flocks that were mixed grew slightly over time at

Okanoya’s study **32** indicates that, song complexity is subject to the pressure of the birds’ need to identify a mate of the same species; when this pressure is relaxed, song complexity increases rather than decreases. Such relaxation explains song complexity in the white-rumped munia’s descendant, the domesticated Bengalese finch, and **33** provides intriguing support for the idea that birdsong can evolve through a complex interaction of selective pressures.

32

- A) NO CHANGE
- B) indicates that—
- C) indicates, that
- D) indicates that

33

The writer wants a conclusion that places the passage’s discussion within a larger scientific context. Which choice best accomplishes this goal?

- A) NO CHANGE
- B) suggests that white-rumped munias and other birds do not have to be domesticated to develop complex songs.
- C) proves that habitat has more to do with birdsong complexity than does any specific mating pressure.
- D) indicates that white-rumped munias have more complex songs than do other kinds of birds.

Questions 34-44 are based on the following passage.

### Eyes in the Sky

— 1 —

Precision agriculture, the use of technology and data analysis in farming, has a new tool at its disposal: the type of remote-controlled aerial vehicle commonly known as a drone. Farmers looking to increase efficiency might decide that drones, **34** which have already proven useful to the film industry, are just what they need.

— 2 —

Detailed data about crop health provided by drones can guide crucial decisions for farmers such as when **35** to irrigate and whether to use chemical treatments? Agricultural drones come equipped with a video or still-image camera that farmers can use to observe the condition of their crops. Some drone companies **36** also offer analysis services: they can combine digital files from drones into color-coded maps that mark zones indicating differences in growth rates or the prevalence of weeds, pests, or weather damage. With these maps, a farmer can irrigate and apply herbicides, pesticides, and fertilizers to each part of a field according to its specific needs.

34

Which choice provides supporting information about drones that is further developed in the passage?

- A) NO CHANGE
- B) along with training in how to operate them properly,
- C) with the critical information they provide about harvests,
- D) despite criticism about them from consumer advocates,

35

- A) NO CHANGE
- B) to irrigate and whether to use chemical treatments.
- C) should they irrigate, and should they use chemical treatments?
- D) should they irrigate, and should they use chemical treatments.

36

Which choice most effectively sets up the information provided in the next part of the sentence?

- A) NO CHANGE
- B) stand to make a considerable profit:
- C) make drones that can be controlled by mobile apps:
- D) focus only on specialty crops:



— 3 —

Drones compare favorably with image-capturing satellites and piloted aircraft, other technologies that are used to gain aerial views. Drones are less expensive, provide finer-grained images, **37** and they fly low to the ground, can take pictures even on cloudy days. Jean Hediger, whose family operates a 3,400-acre organic grain farm in Colorado, can attest to the advantages of the technology. Hediger **38** acquired a drone after losing half of her harvest in one year to weeds. She estimates that identifying problems faster with timely crop data and using less weed killer **39** will save her tens of thousands of dollars in future **40** years. Considerably more than the \$7,000 she paid for the drone and any potential costs associated with reviewing images.

**37**

- A) NO CHANGE
- B) and
- C) and therefore
- D) and, because they

**38**

Which information about Hediger provides the most effective transition between the previous sentence and the following sentence in the paragraph?

- A) NO CHANGE
- B) considered acquiring a drone from Corey Jacobs, who runs a farm in Indiana.
- C) has expressed frustration with federal regulations on drones.
- D) enjoys having an aerial view of her farm.

**39**

- A) NO CHANGE
- B) had saved
- C) are saving
- D) have saved

**40**

- A) NO CHANGE
- B) years—considerably
- C) years, this is considerably
- D) years; considerably

— 4 —

Pilots who fly planes for crop dusting and other purposes **41** experience disquiet regarding the presence of drones in the airspace above farms. Drones might be accidentally flown into nearby tall objects such as cell phone towers. Objections to drones may be **42** engaged with regulations that require drone operators to keep drones within sight at all times and that require lights on drones to ensure they are visible.

41

- A) NO CHANGE
- B) stew over
- C) get all worked up about
- D) worry about

42

- A) NO CHANGE
- B) addressed
- C) encountered
- D) refuted

— 5 —

Despite these challenges, it is important for drones **43** being integrated into the agricultural system. If they are used effectively, drones hold the promise of making farms more productive and cost effective while minimizing waste in water and chemical treatments, which could benefit farmers, consumers, and the environment alike.

**Question 44** asks about the previous passage as a whole.

**43**

- A) NO CHANGE
- B) in being
- C) to be
- D) be

**Think about the previous passage as a whole as you answer question 44.**

**44**

The writer wants to insert the following sentence.

Any discussion of agricultural drones must acknowledge the potential safety concerns surrounding their use.

To make the passage most logical, the sentence should be placed at the beginning of paragraph

- A) 2.
- B) 3.
- C) 4.
- D) 5.

**STOP**

**If you finish before time is called, you may check your work on this section only.  
Do not turn to any other section.**



# Math Test – No Calculator

25 MINUTES, 20 QUESTIONS

Turn to Section 3 of your answer sheet to answer the questions in this section.

## DIRECTIONS

For questions 1-15, solve each problem, choose the best answer from the choices provided, and fill in the corresponding bubble on your answer sheet. For questions 16-20, solve the problem and enter your answer in the grid on the answer sheet. Please refer to the directions before question 16 on how to enter your answers in the grid. You may use any available space in your test booklet for scratch work.

## NOTES

- The use of a calculator **is not permitted**.
- All variables and expressions used represent real numbers unless otherwise indicated.
- Figures provided in this test are drawn to scale unless otherwise indicated.
- All figures lie in a plane unless otherwise indicated.
- Unless otherwise indicated, the domain of a given function  $f$  is the set of all real numbers  $x$  for which  $f(x)$  is a real number.

## REFERENCE

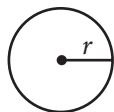

$$A = \pi r^2$$

$$C = 2\pi r$$

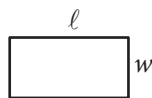

$$A = \ell w$$

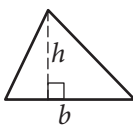

$$A = \frac{1}{2}bh$$

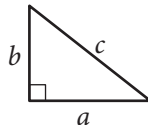

$$c^2 = a^2 + b^2$$

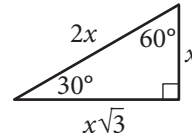

Special Right Triangles

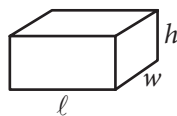
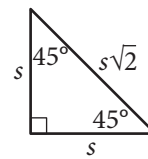

$$V = \ell wh$$

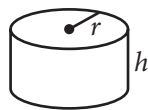

$$V = \pi r^2 h$$



$$V = \frac{4}{3}\pi r^3$$

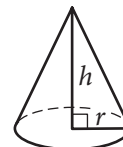

$$V = \frac{1}{3}\pi r^2 h$$

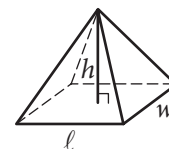

$$V = \frac{1}{3}\ell wh$$

The number of degrees of arc in a circle is 360.

The number of radians of arc in a circle is  $2\pi$ .

The sum of the measures in degrees of the angles of a triangle is 180.



1

Juliet rented a car for one day from a company that charges \$80 per day plus \$0.15 per mile driven. If she was charged a total of \$98 for the rental and mileage, for how many miles of driving was Juliet charged? (Assume there is no tax.)

- A) 15
- B) 120
- C) 533
- D) 633

2

$$(2x + 6) + (x^2 + 2x + 1)$$

Which of the following polynomials is equivalent to the expression above?

- A)  $x^2 + 5$
- B)  $x^2 + 7$
- C)  $4x^2 + 7$
- D)  $x^2 + 4x + 7$

3

$$f(x) = 2(x - 1) + 2$$

For the function  $f$  defined above, what is the value of  $f(1)$  ?

- A) 3
- B) 2
- C) 0
- D) -1

4

Which of the following is an equation of the line in the  $xy$ -plane that has slope 2 and passes through the point  $(0, 3)$  ?

- A)  $y = 2x + 3$
- B)  $y = 2x - 3$
- C)  $y = 2(x + 3)$
- D)  $y = 2(x - 3)$

5

$$\sqrt{x} + 4 = 12$$

Which of the following is the solution to the equation above?

- A) 8
- B) 16
- C) 64
- D) 140



6

If  $7(2x - 5) - 2(2x - 5) = 4(x + 5)$ , what is the value of  $x$ ?

- A) 1
- B)  $\frac{15}{2}$
- C)  $\frac{65}{6}$
- D) 65

7

$$x^4 - 8x^2 + 16$$

Which of the following is equivalent to the expression above?

- A)  $(x - 2)^2(x + 2)^2$
- B)  $(x^2 + 4)(x + 2)(x - 2)$
- C)  $(x - 2)^4$
- D)  $(x - 4)^4$

8

$$V = \frac{M}{D}$$

The formula above relates volume  $V$ , mass  $M$ , and density  $D$ . What is density in terms of volume and mass?

- A)  $D = \frac{1}{MV}$
- B)  $D = \frac{M}{V}$
- C)  $D = \frac{V}{M}$
- D)  $D = MV$

9

For a ride, a taxi driver charges an initial fare of \$3.00 plus \$0.40 for each  $\frac{1}{5}$  of a mile driven. If the total charge for a ride is \$27.00, what is the distance traveled, in miles?

- A) 3
- B) 8
- C) 12
- D) 15



10

$$\frac{1}{2}mv^2 = mgh$$

Torricelli's law is given by the equation above, where  $m$  represents the mass,  $h$  represents the height,  $v$  represents the velocity, and  $g$  is a constant. According to the equation from Torricelli's law, which of the following is equivalent to the velocity,  $v$ ?

- A)  $2gh$
- B)  $\frac{1}{2}ghm^2$
- C)  $\sqrt{2gh}$
- D)  $\sqrt{\frac{1}{2}mgh}$

11

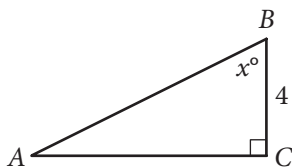

Note: Figure not drawn to scale.

In the right triangle above,  $x = 60$ . What is the length of side  $\overline{AB}$ ?

- A) 7
- B) 8
- C) 9
- D) It cannot be determined from the information given.

12

$$4v^2 + 6v + 1 = 0$$

Which of the following values is a solution to the equation above?

- A)  $\frac{-3 + \sqrt{5}}{4}$
- B)  $\frac{-3 + \sqrt{13}}{4}$
- C)  $\frac{3 + \sqrt{5}}{4}$
- D)  $\frac{3 + \sqrt{13}}{4}$

13

$$C(t) = 50.25t + 228.75$$

The average cost per square foot, in dollars, of a condominium in City X can be modeled by the function  $C$  defined above, where  $t$  is the number of years after 2001 and  $0 \leq t \leq 8$ . In the function, what does the number 50.25 represent?

- A) The average cost per square foot, in dollars, of a condominium in 2001
- B) The average cost per square foot, in dollars, of a condominium in 2009
- C) The approximate increase in years for each dollar increase in the average cost per square foot of a condominium
- D) The approximate increase in the average cost per square foot, in dollars, of a condominium for each additional year after 2001



14

What is the sum of the complex numbers  $6 + 5i$  and  $8 + 3i^2$ ? (Note:  $i = \sqrt{-1}$ )

- A)  $11 + 5i$
- B)  $14 - 2i$
- C)  $14 + 8i^3$
- D)  $17 + 5i$

15

Which of the following could be the graph of  $y = x^2 + 2x + 2$ ?

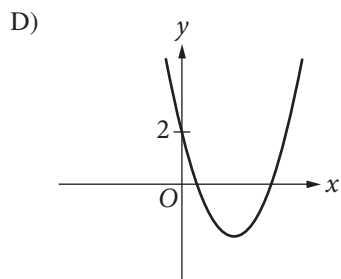
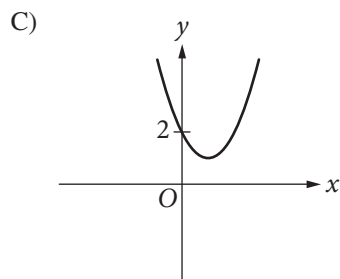
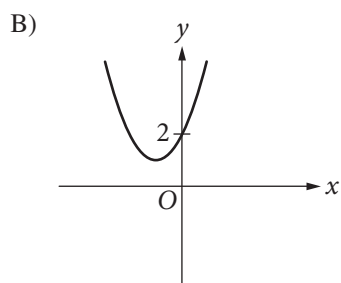
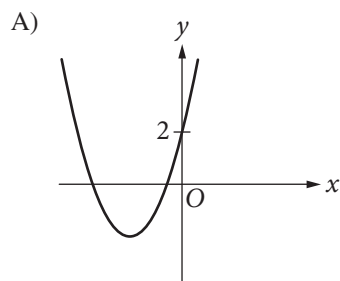





**DIRECTIONS**

For questions 16-20, solve the problem and enter your answer in the grid, as described below, on the answer sheet.

- Although not required, it is suggested that you write your answer in the boxes at the top of the columns to help you fill in the bubbles accurately. You will receive credit only if the bubbles are filled in correctly.
- Mark no more than one bubble in any column.
- No question has a negative answer.
- Some problems may have more than one correct answer. In such cases, grid only one answer.
- Mixed numbers** such as  $3\frac{1}{2}$  must be gridded as 3.5 or 7/2. (If 

3	1	/	2
<input type="radio"/>	<input type="radio"/>	<input type="radio"/>	<input type="radio"/>
<input type="radio"/>	<input type="radio"/>	<input type="radio"/>	<input type="radio"/>
<input type="radio"/>	<input type="radio"/>	<input type="radio"/>	<input type="radio"/>

 is entered into the grid, it will be interpreted as  $\frac{31}{2}$ , not  $3\frac{1}{2}$ .)
- Decimal answers:** If you obtain a decimal answer with more digits than the grid can accommodate, it may be either rounded or truncated, but it must fill the entire grid.

Answer:  $\frac{7}{12}$

Write answer in boxes. →

7	/	1	2
<input type="radio"/>	<input type="radio"/>	<input type="radio"/>	<input type="radio"/>
<input type="radio"/>	<input type="radio"/>	<input type="radio"/>	<input type="radio"/>
1	1	1	1
2	2	2	2
3	3	3	3
4	4	4	4
5	5	5	5
6	6	6	6
<input checked="" type="radio"/>	7	7	7
8	8	8	8
9	9	9	9

Grid in result. ←

Answer: 2.5

	2	.	5
<input type="radio"/>	<input type="radio"/>	<input type="radio"/>	<input type="radio"/>
<input type="radio"/>	<input type="radio"/>	<input type="radio"/>	<input type="radio"/>
1	1	1	1
2	2	2	2
3	3	3	3
4	4	4	4
5	5	5	<input checked="" type="radio"/>
6	6	6	6
7	7	7	7
8	8	8	8
9	9	9	9

← Fraction line

← Decimal point

Acceptable ways to grid  $\frac{2}{3}$  are:

	2	/	3
<input type="radio"/>	<input type="radio"/>	<input type="radio"/>	<input type="radio"/>
<input type="radio"/>	<input type="radio"/>	<input type="radio"/>	<input type="radio"/>
1	1	1	1
2	2	2	2
3	3	3	<input checked="" type="radio"/>
4	4	4	4
5	5	5	5
6	6	6	6
7	7	7	7
8	8	8	8

.	6	6	6
<input type="radio"/>	<input type="radio"/>	<input type="radio"/>	<input type="radio"/>
<input type="radio"/>	<input type="radio"/>	<input type="radio"/>	<input type="radio"/>
1	1	1	1
2	2	2	2
3	3	3	3
4	4	4	4
5	5	5	5
6	<input checked="" type="radio"/>	<input checked="" type="radio"/>	<input checked="" type="radio"/>
7	7	7	7
8	8	8	8

.	6	6	7
<input type="radio"/>	<input type="radio"/>	<input type="radio"/>	<input type="radio"/>
<input type="radio"/>	<input type="radio"/>	<input type="radio"/>	<input type="radio"/>
1	1	1	1
2	2	2	2
3	3	3	3
4	4	4	4
5	5	5	5
6	6	6	6
7	7	7	<input checked="" type="radio"/>
8	8	8	8

Answer: 201 – either position is correct

	2	0	1
<input type="radio"/>	<input type="radio"/>	<input type="radio"/>	<input type="radio"/>
<input type="radio"/>	<input type="radio"/>	<input type="radio"/>	<input type="radio"/>
1	1	1	<input checked="" type="radio"/>
2	2	2	2
3	3	3	3

2	0	1	
<input type="radio"/>	<input type="radio"/>	<input type="radio"/>	<input type="radio"/>
<input type="radio"/>	<input type="radio"/>	<input type="radio"/>	<input type="radio"/>
1	1	<input checked="" type="radio"/>	1
2	2	2	2
3	3	3	3

**NOTE:**  
You may start your answers in any column, space permitting. Columns you don't need to use should be left blank.



16

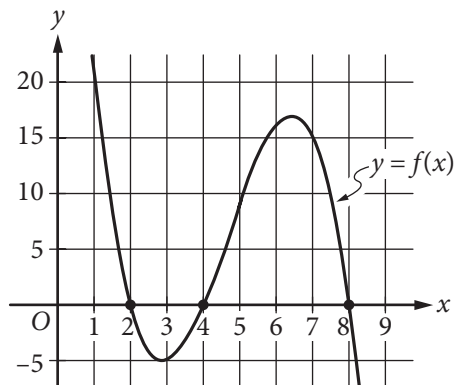

The graph of the cubic function  $f$  is shown in the  $xy$ -plane above. If  $f(a) = 0$ , where  $a$  is a constant, what is one possible value of  $a$ ?

17

$$5(x + a) + 3(x^2 - a) = 3x^2 + 5x + 4$$

In the equation above,  $a$  is a constant. If the equation is true for all values of  $x$ , what is the value of  $a$ ?

18

$$3m + 2p = 24$$

$$m + p = 10$$

If  $(m_1, p_1)$  is the solution to the system of equations above, what is the value of  $p_1$ ?

19

$$4x - 5y = 2$$

The graph of the equation above in the  $xy$ -plane is a line. What is the  $x$ -coordinate of the  $x$ -intercept of the line?

20

$$(x - 6)^2 + (y - 3)^2 = 25$$

The graph in the  $xy$ -plane of the equation above is a circle. If the circle is translated downward  $a$  units such that the circle is tangent to the  $x$ -axis, the equation becomes  $(x - 6)^2 + (y - 3 + a)^2 = 25$ . What is the value of  $a$ ?

# STOP

**If you finish before time is called, you may check your work on this section only.**

**Do not turn to any other section.**



# Math Test – Calculator

55 MINUTES, 38 QUESTIONS

Turn to Section 4 of your answer sheet to answer the questions in this section.

## DIRECTIONS

For questions 1-30, solve each problem, choose the best answer from the choices provided, and fill in the corresponding bubble on your answer sheet. For questions 31-38, solve the problem and enter your answer in the grid on the answer sheet. Please refer to the directions before question 31 on how to enter your answers in the grid. You may use any available space in your test booklet for scratch work.

## NOTES

- The use of a calculator **is permitted**.
- All variables and expressions used represent real numbers unless otherwise indicated.
- Figures provided in this test are drawn to scale unless otherwise indicated.
- All figures lie in a plane unless otherwise indicated.
- Unless otherwise indicated, the domain of a given function  $f$  is the set of all real numbers  $x$  for which  $f(x)$  is a real number.

## REFERENCE

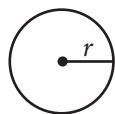

$$A = \pi r^2$$

$$C = 2\pi r$$

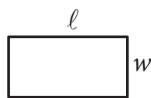

$$A = \ell w$$

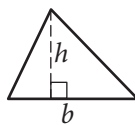

$$A = \frac{1}{2}bh$$

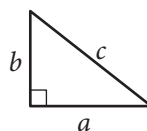

$$c^2 = a^2 + b^2$$

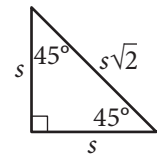
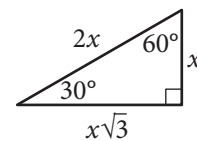

Special Right Triangles

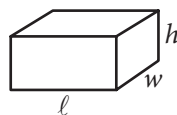

$$V = \ell wh$$

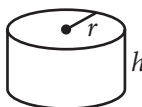

$$V = \pi r^2 h$$



$$V = \frac{4}{3}\pi r^3$$



$$V = \frac{1}{3}\pi r^2 h$$

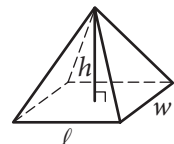

$$V = \frac{1}{3}\ell wh$$

The number of degrees of arc in a circle is 360.

The number of radians of arc in a circle is  $2\pi$ .

The sum of the measures in degrees of the angles of a triangle is 180.



1

$$5(x - 3) = 10x + 5$$

What value of  $x$  satisfies the equation above?

- A) -4
- B) 1
- C) 5
- D) 15

2

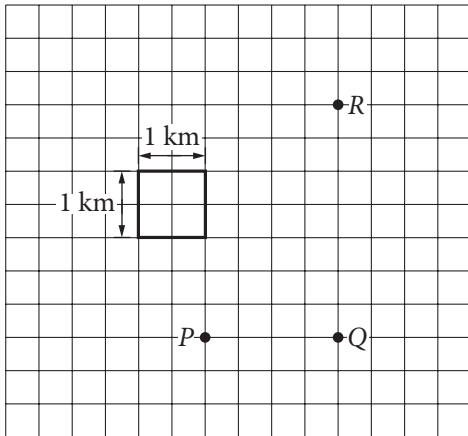

A student walks  $x$  kilometers (km) along a straight path from point  $P$  to point  $Q$ . Then the student walks  $y$  km along a straight path from point  $Q$  to point  $R$ . What is the total distance,  $x + y$ , in km, that the student walks?

- A) 2.0
- B) 3.5
- C) 5.5
- D) 8.0

3

If  $y = x + \frac{1}{2}$  and  $z = 2x - 3$ , which of the following is equivalent to  $y + yz$  ?

- A)  $2x^2 - x - 1$
- B)  $2x^2 - x - 2$
- C)  $2x^2 - x - \frac{1}{2}$
- D)  $2x^2 - 2x - \frac{3}{2}$

4

An electric company charges Jerome \$0.05 per kilowatt-hour (kWh) of energy he uses in his house. If Jerome was charged \$36 by the electric company, how many kilowatt-hours of energy did Jerome use?

- A) 0.0014
- B) 1.8
- C) 180
- D) 720



5

A scientist conducted an experiment and selected a random sample of runners from a list of all high school track participants from a certain city. The scientist randomly assigned each runner to one of two treatment groups, and the results of the experiment were found to be statistically significant. To which of the following populations can the results of the experiment be safely generalized?

- A) All high school athletes
- B) All high school track participants from the city
- C) All high school track participants from the country
- D) All runners

6

Which of the following equivalent forms of the function  $f(x) = 4x^2 + 4x - 24$  is the most suitable to indicate the  $x$ -coordinates of the  $x$ -intercepts of the graph of  $y = f(x)$  in the  $xy$ -plane?

- A)  $f(x) = 4(x^2 + x - 6)$
- B)  $f(x) = 4(x - 2)(x + 3)$
- C)  $f(x) = 2(x - 2)(2x + 6)$
- D)  $f(x) = (2x - 4)(2x + 6)$

7

Raymond's weekly income consists of a base salary for a 40-hour workweek plus overtime pay. The overtime pay is paid at an hourly rate for the time that Raymond works in addition to his 40-hour workweek. Raymond's weekly income, in dollars, can be represented by the expression  $800 + 30x$ , where  $x$  is the total number of hours Raymond works over 40 hours. Which of the following is the best interpretation of the number 800 in this context?

- A) Raymond's base weekly salary, in dollars
- B) Raymond's total overtime pay for the workweek, in dollars
- C) The total number of hours in a year that Raymond works in addition to his normal 40-hour workweeks
- D) Raymond's hourly wage, in dollars per hour, for time worked in addition to his normal 40-hour workweek

8

A city with 120,000 residents is voting on a proposal that would eliminate overnight parking of vehicles on the city's streets. An independent company randomly surveys 1,200 residents to see whether or not residents would support this proposal. The outcome of the survey shows that 60% of the residents surveyed approve of the proposal with a margin of error of 2%. Which of the following statements is a plausible conclusion from the outcome of the survey?

- A) Exactly 60% of city residents approve eliminating overnight parking.
- B) There are 72,000 city residents who approve eliminating overnight parking.
- C) About 2% of the city residents do not approve eliminating overnight parking.
- D) Between 58% and 62% of the city residents approve eliminating overnight parking.



9

On November 1st, there were 2,500 boxes in a warehouse. On December 1st, there were 15% fewer boxes in the warehouse than there were on November 1st. On January 1st, there were 20% more boxes in the warehouse than there were on December 1st. How many boxes were in the warehouse on January 1st?

- A) 1,700
- B) 2,125
- C) 2,550
- D) 2,625

10

Jonathan needs to earn at least \$175 next week and can work at most 20 hours. He earns \$10 per hour at his lawn service job and \$8 per hour at his job at the gym. Which of the following systems of inequalities represents this situation in terms of the number of hours he will work at his lawn service job,  $\ell$ , and the number of hours he will work at his job at the gym,  $g$ , next week?

- A)  $10\ell + 8g \leq 175$   
 $\ell + g \leq 20$
- B)  $10\ell + 8g \leq 175$   
 $\ell + g \geq 20$
- C)  $10\ell + 8g \geq 175$   
 $\ell + g \leq 20$
- D)  $10\ell + 8g \geq 20$   
 $\ell + g \geq 175$

11

Future Value of an Investment after 20 Years for Different Interest Rates

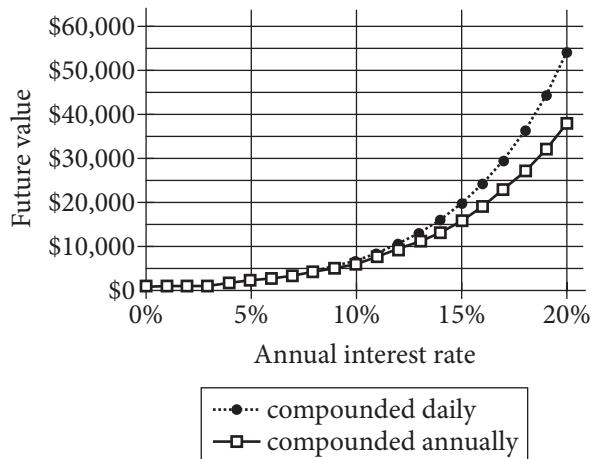

An initial investment of \$1,000 is made at a constant annual interest rate. The graphs above show the corresponding future value  $v$ , in dollars, of the investment for different annual interest rates,  $r$ , after 20 years. One graph shows the value when the interest is compounded daily, and the other graph shows the value when the interest is compounded annually. Which of the following statements is true?

- A) As  $r$  increases at a constant rate,  $v$  increases more rapidly if interest is compounded annually rather than daily.
- B) As  $r$  increases at a constant rate,  $v$  increases more rapidly if interest is compounded daily rather than annually.
- C) As  $r$  increases at a constant rate, the difference in interest compounded daily and interest compounded annually increases at a constant rate.
- D) If  $r = 15\%$  and interest is compounded annually, a \$1,000 investment will be worth \$20,000 after 20 years.



Questions 12-14 refer to the following information.

For gym class, Shayla completed a 4-mile walking and running exercise. She ran for  $7t$  miles and she walked for

$3\left(\frac{13}{15} - t\right)$  miles, where  $t$  is the total amount of time,

in hours, Shayla spent running. The equation

$7t + 3\left(\frac{13}{15} - t\right) = 4$  models this situation.

12

Which of the following is the best interpretation of the value 7 in the equation that models this situation?

- A) Shayla walked at a speed of 7 miles per hour.
- B) Shayla ran at a speed of 7 miles per hour.
- C) Shayla walked for 7 minutes.
- D) Shayla ran for 7 minutes.

13

What is the value of  $t$  in the equation that models this situation?

- A)  $\frac{7}{50}$
- B)  $\frac{7}{20}$
- C)  $\frac{31}{60}$
- D)  $\frac{13}{15}$

14

What was the total distance that Shayla spent walking and running, in kilometers?  
(Use 1 mile = 1.61 kilometers)

- A) 0.40
- B) 4.00
- C) 6.44
- D) 10.53



15

Which of the following is a graph of a system of equations with no solution?

A)

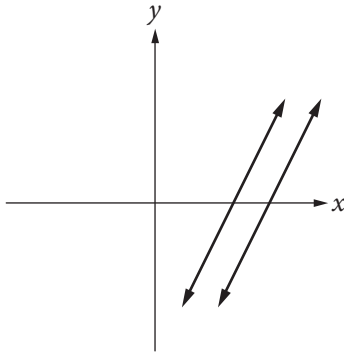

B)

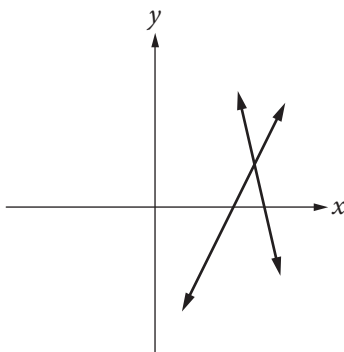

C)

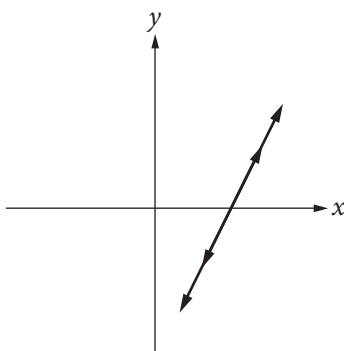

D)

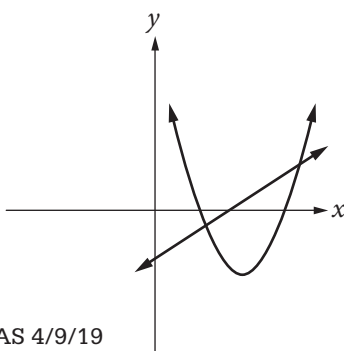

16

$$P = P_0 + \rho gh$$

The equation above gives the total pressure,  $P$ , on an object submerged in a fluid, where  $P_0$  is the pressure at the fluid's surface,  $\rho$  is the density of the fluid,  $g$  is the acceleration due to gravity, and  $h$  is the depth to which the object is submerged. What is  $h$  in terms of  $P$ ,  $P_0$ ,  $\rho$ , and  $g$ ?

A)  $\frac{\rho g}{P - P_0}$

B)  $\frac{P - P_0}{\rho g}$

C)  $\frac{P + P_0}{\rho g}$

D)  $P + P_0 + \rho g$

17

If  $4x^2 + bx + 9 = 0$ , where  $b$  is a constant, has exactly one solution, what is a possible value of  $b$ ?

A) 72

B) 36

C) 12

D) 6





18

	Female	Male	Total
Blue eyes	2	4	6
Brown eyes	8	6	14
Green eyes	1	5	6
Total	11	15	26

Sierra recorded the gender and eye color of all the students in her biology class. The results are shown in the table above. If a male student is selected at random from Sierra's biology class, what is the probability that he will have brown eyes?

- A)  $\frac{2}{3}$   
 B)  $\frac{2}{5}$   
 C)  $\frac{3}{7}$   
 D)  $\frac{3}{13}$

19

Kelly enlarged the area of a photograph to 250% of its original size. The original dimensions of the photograph were 5 inches by 7 inches. What is the area of the enlarged photograph, in square inches?

- A) 71.25  
 B) 87.5  
 C) 218.75  
 D) 3,000

20

$$\sqrt{x-3} = 3 - \sqrt{x}$$

If  $x$  is the solution to the equation above, what is the value of  $\sqrt{x-3}$ ?

- A) 1  
 B)  $\sqrt{\frac{3}{2}}$   
 C)  $\sqrt{3}$   
 D) 3

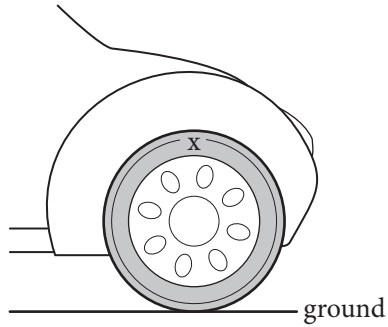

In the figure above, X is a mark on the side of a tire of a car at rest. The car, starting from rest, will experience an acceleration for some period of time. Which of the following graphs could represent the distance between the mark X and the ground after the car starts to accelerate and the tire makes its first few revolutions?

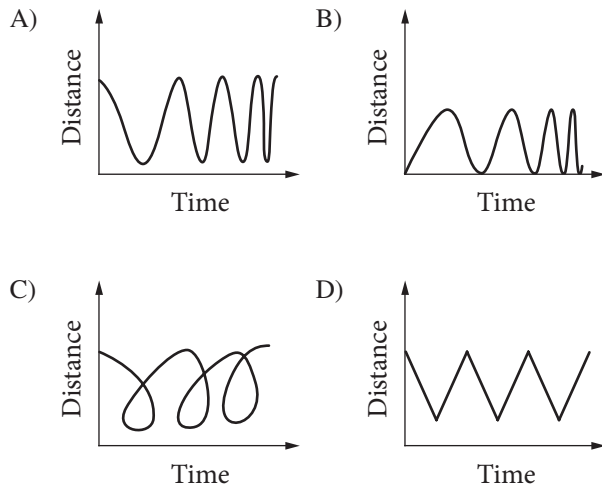



22

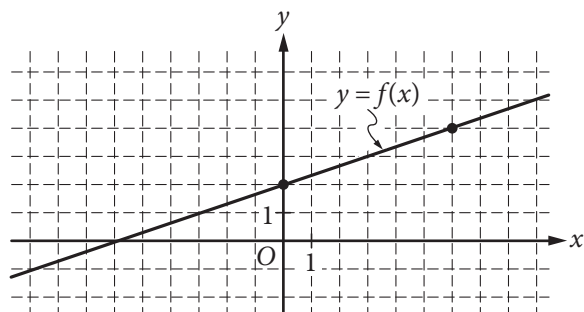

The graph of the function  $f$  is shown in the  $xy$ -plane

above. The function  $f$  is defined by the equation

$$f(x) = \frac{a}{b}x + c \text{ for positive constants } a, b, \text{ and } c,$$

where  $\frac{a}{b}$  is a fraction in lowest terms. Which of the

following orders  $a$ ,  $b$ , and  $c$  from least to greatest?

- A)  $a < b < c$
- B)  $a < c < b$
- C)  $b < c < a$
- D)  $c < a < b$

23

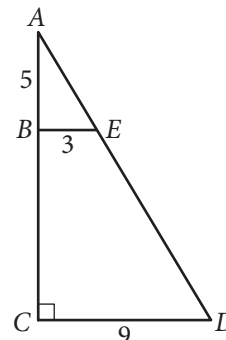

In the figure above,  $\triangle ACD$  is a right triangle and  $\overline{BE}$  is parallel to  $\overline{CD}$ . What is the perimeter of  $\triangle ACD$  to the nearest tenth of a unit?

- A) 29.7
- B) 36.0
- C) 41.5
- D) 50.9

24

In the  $xy$ -plane, the graph of a linear equation of the form  $y = mx + b$  and the graph of an exponential equation of the form  $y = ab^x$  both contain points  $(1, 3)$  and  $(2, 4)$ . If the point  $(r, s)$  is on the graph of the linear equation and the point  $(r, t)$  is on the graph of the exponential equation, where  $0 < r < 4$  and  $s > t$ , which of the following must be true?

- A)  $0 < r < 1$
- B)  $1 < r < 2$
- C)  $2 < r < 3$
- D)  $3 < r < 4$



25

Two independent surveys asked random samples of 500 people about the distances they commute to work each day. The results of the surveys are detailed in the table below.

Daily Commuting Distance

Survey	Mean (miles)	Standard deviation (miles)
A	13.9	1.5
B	15.1	1.5

Which statement is true based on the results of these surveys?

- A) There is a greater variation in the distribution of the distances people commute to work in Survey A.
- B) There is a greater variation in the distribution of the distances people commute to work in Survey B.
- C) The variation in the distribution of the distances people commute is the same in both surveys.
- D) It is impossible to determine the variation in the distribution of the distances people commute because the means are different.

26

During an ice age, the average annual global temperature was at least 4 degrees Celsius lower than the modern average. If the average annual temperature of an ice age is  $y$  degrees Celsius and the modern average annual temperature is  $x$  degrees Celsius, which of the following must be true?

- A)  $y = x - 4$
- B)  $y \leq x + 4$
- C)  $y \geq x - 4$
- D)  $y \leq x - 4$



27

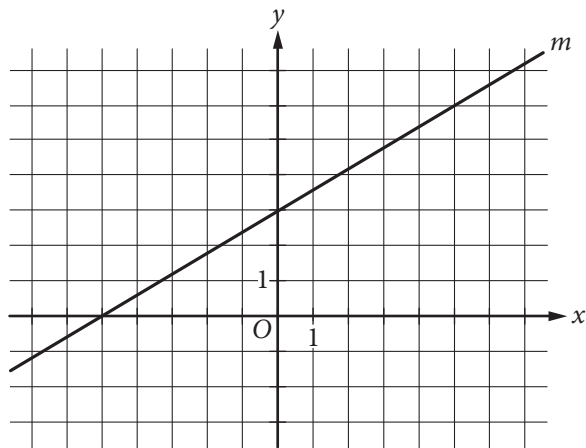

In the  $xy$ -plane above, line  $m$  is perpendicular to line  $\ell$  (not shown). Which of the following could be an equation of line  $\ell$ ?

- A)  $5x + 3y + 3 = 0$
- B)  $5x - 3y + 3 = 0$
- C)  $3x - 5y + 15 = 0$
- D)  $3x + 5y - 15 = 0$

28

Maximum Speed versus Maximum Height of 12 Roller Coasters

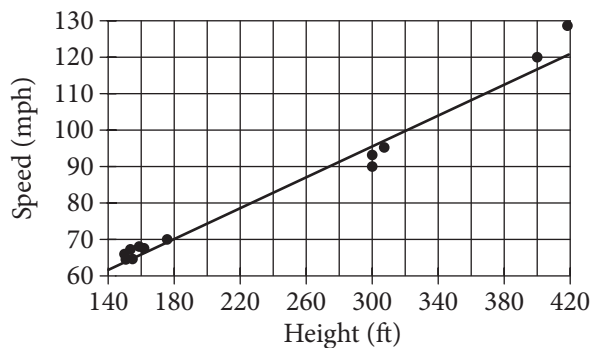

The scatterplot above shows the maximum height  $h$ , in feet (ft), and maximum speed  $s$ , in miles per hour (mph), of 12 roller coasters as well as the line of best fit for the data. Of the following, which best represents an equation for the line of best fit?

- A)  $s = 0.21h + 32$
- B)  $s = 0.43h + 32$
- C)  $s = 0.21h + 62$
- D)  $s = 0.43h + 62$



29

Selena created a scale model of an airplane where 1 centimeter on the model equals 6 meters on the airplane. The wingspan of the model is 10.7 centimeters. Selena wants to make a new model where a scale of 1 centimeter on the model equals 3 meters on the airplane. Which of the following best describes how the wingspan of the new model will compare to the wingspan of the first model?

- A) The wingspan of the new model will be 3 centimeters shorter than the first model.
- B) The wingspan of the new model will be 3 centimeters longer than the first model.
- C) The wingspan of the new model will be  $\frac{1}{2}$  as long as the wingspan of the first model.
- D) The wingspan of the new model will be 2 times as long as the wingspan of the first model.

30

Hongbo sold  $x$  cell phones in 2013. The number of cell phones he sold in 2014 was 128% greater than in 2013, and the number of cell phones he sold in 2015 was 29% greater than in 2014. Which of the following expressions represents the number of cell phones Hongbo sold in 2015?

- A)  $(0.29)(1.28x)$
- B)  $(0.29)(2.28x)$
- C)  $(1.29)(1.28x)$
- D)  $(1.29)(2.28x)$

**DIRECTIONS**

For questions 31-38, solve the problem and enter your answer in the grid, as described below, on the answer sheet.

- Although not required, it is suggested that you write your answer in the boxes at the top of the columns to help you fill in the bubbles accurately. You will receive credit only if the bubbles are filled in correctly.
- Mark no more than one bubble in any column.
- No question has a negative answer.
- Some problems may have more than one correct answer. In such cases, grid only one answer.
- Mixed numbers** such as  $3\frac{1}{2}$  must be gridded as 3.5 or 7/2. (If 

3	1	/	2
<input type="radio"/>	<input type="radio"/>	<input type="radio"/>	<input type="radio"/>
<input type="radio"/>	<input type="radio"/>	<input type="radio"/>	<input type="radio"/>

 is entered into the grid, it will be interpreted as  $\frac{31}{2}$ , not  $3\frac{1}{2}$ .)
- Decimal answers:** If you obtain a decimal answer with more digits than the grid can accommodate, it may be either rounded or truncated, but it must fill the entire grid.

Write answer in boxes. →

Grid in result. →

← Fraction line

← Decimal point

Answer: $\frac{7}{12}$			
7	/	1	2
<input type="radio"/>	<input type="radio"/>	<input type="radio"/>	<input type="radio"/>
<input type="radio"/>	<input type="radio"/>	<input type="radio"/>	<input type="radio"/>
1	1	1	1
2	2	2	2
3	3	3	3
4	4	4	4
5	5	5	5
6	6	6	6
<input checked="" type="radio"/>	7	7	7
8	8	8	8
9	9	9	9

Answer: 2.5			
	2	.	5
<input type="radio"/>	<input type="radio"/>	<input type="radio"/>	<input type="radio"/>
<input type="radio"/>	<input type="radio"/>	<input type="radio"/>	<input type="radio"/>
1	1	1	1
2	2	2	2
3	3	3	3
4	4	4	4
5	5	5	5
6	6	6	6
7	7	7	7
8	8	8	8
9	9	9	9

Acceptable ways to grid  $\frac{2}{3}$  are:

	2	/	3
<input type="radio"/>	<input type="radio"/>	<input type="radio"/>	<input type="radio"/>
<input type="radio"/>	<input type="radio"/>	<input type="radio"/>	<input type="radio"/>
1	1	1	1
2	2	2	2
3	3	3	3
4	4	4	4
5	5	5	5
6	6	6	6
7	7	7	7
8	8	8	8

.	6	6	6
<input type="radio"/>	<input type="radio"/>	<input type="radio"/>	<input type="radio"/>
<input type="radio"/>	<input type="radio"/>	<input type="radio"/>	<input type="radio"/>
1	1	1	1
2	2	2	2
3	3	3	3
4	4	4	4
5	5	5	5
6	6	6	6
7	7	7	7
8	8	8	8

.	6	6	7
<input type="radio"/>	<input type="radio"/>	<input type="radio"/>	<input type="radio"/>
<input type="radio"/>	<input type="radio"/>	<input type="radio"/>	<input type="radio"/>
1	1	1	1
2	2	2	2
3	3	3	3
4	4	4	4
5	5	5	5
6	6	6	6
7	7	7	7
8	8	8	8

Answer: 201 – either position is correct

	2	0	1
<input type="radio"/>	<input type="radio"/>	<input type="radio"/>	<input type="radio"/>
<input type="radio"/>	<input type="radio"/>	<input type="radio"/>	<input type="radio"/>
1	1	1	1
2	2	2	2
3	3	3	3

2	0	1	
<input type="radio"/>	<input type="radio"/>	<input type="radio"/>	<input type="radio"/>
<input type="radio"/>	<input type="radio"/>	<input type="radio"/>	<input type="radio"/>
1	1	1	1
2	2	2	2
3	3	3	3

**NOTE:**

You may start your answers in any column, space permitting. Columns you don't need to use should be left blank.



31

Anna was 99 centimeters tall the day she turned 3 years old, and she was 106.5 centimeters tall the day she turned 4 years old. If Anna's height increases by the same amount each year between the ages of 2 and 8, how many centimeters tall will she be the day she turns 7 years old?

32

Cars Registered in Town X

Car color	Percent of registered cars
Black	13%
Blue	7%
Gray	7%
Silver	28%
White	32%
Other	13%

The table above shows the distribution of color for the 4000 cars registered in Town X. Based on the table, how many more white cars than black cars are registered in Town X?

33

$$3x + 2y = 16$$

$$6x + 2y = 28$$

If the system of equations above has solution  $(x, y)$ , what is the value of  $x + y$ ?

34

Monthly Enrollments in Art Classes

Community center	Jan	Feb	Mar	Apr	May	Jun	Jul
A	124	111	98	82	77	152	133
B	465	407	391	354	365	511	495

The table above shows monthly enrollments in art classes at two community centers for 7 consecutive months. Based on the table, by how much does the median monthly enrollment in community center B exceed the median monthly enrollment in community center A for the 7 months?

35

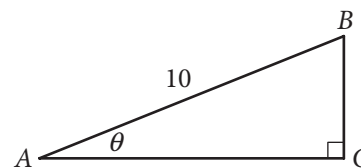

In the right triangle above,  $\sin \theta = \frac{2}{5}$ . If  $AC = \sqrt{n}$ , what is the value of  $n$ ?

36

In the  $xy$ -plane, the graph of  $y = x^2 + bx + c$ , where  $b$  and  $c$  are constants, has  $x$ -intercepts at  $x = -2$  and  $x = -6$ . What is the value of  $b$ ?





Questions 37 and 38 refer to the following information.

A contractor purchased two slabs of granite, both in the shape of a right rectangular prism. The table below shows some information about the two slabs.

	Length	Width	Thickness	Mass
Slab 1	100 centimeters	20 centimeters	8 centimeters	44,000 grams
Slab 2	125 centimeters		8 centimeters	

37

What is the density, in grams per cubic centimeter, of Slab 1 ?

38

Slab 2 has a ratio of length to width of 5 to 2. How many centimeters wide is Slab 2 ?

**STOP**

**If you finish before time is called, you may check your work on this section only.  
Do not turn to any other section.**

# Essay

---

## **DIRECTIONS**

The essay gives you an opportunity to show how effectively you can read and comprehend a passage and write an essay analyzing the passage. In your essay, you should demonstrate that you have read the passage carefully, present a clear and logical analysis, and use language precisely.

Your essay must be written on the lines provided in your answer booklet; except for the Planning Page of the answer booklet, you will receive no other paper on which to write. You will have enough space if you write on every line, avoid wide margins, and keep your handwriting to a reasonable size. Remember that people who are not familiar with your handwriting will read what you write. Try to write or print so that what you are writing is legible to those readers.

## **REMINDERS**

1. **Do not write your essay in this booklet.** Only what you write on the lined pages of your answer booklet will be evaluated.
2. **An off-topic essay will not be evaluated.**

**You have 50 minutes (standard time) to read the passage and write an essay in response to the prompt provided inside this booklet.**

---

As you read the passage below, consider how Arthur Schlesinger Jr. uses

- evidence, such as facts or examples, to support claims.
- reasoning to develop ideas and to connect claims and evidence.
- stylistic or persuasive elements, such as word choice or appeals to emotion, to add power to the ideas expressed.

**Adapted from Arthur Schlesinger Jr., “Against a One-Term, 6-Year President.”  
©1986 by The New York Times Company. Originally published January 10, 1986.**

- 1 The proposal of a single six-year Presidential term has been around for a long time. High-minded men have urged it from the beginning of the Republic. The Constitutional Convention turned it down in 1787, and recurrent efforts to put it in the Constitution have regularly failed in the two centuries since. Quite right: It is a terrible idea for a number of reasons, among them that it is at war with the philosophy of democracy.
- 2 The basic argument for the one-term, six-year Presidency is that the quest for re-election is at the heart of our problems with self-government. The desire for re-election, it is claimed, drives Presidents to do things they would not otherwise do. It leads them to make easy promises and to postpone hard decisions. A single six-year term would liberate Presidents from the pressures and temptations of politics. Instead of worrying about re-election, they would be free to do only what was best for the country.
- 3 The argument is superficially attractive. But when you think about it, it is profoundly anti-democratic in its implications. It assumes Presidents know better than anyone else what is best for the country and that the people are so wrongheaded and ignorant that Presidents should be encouraged to disregard their wishes. It assumes that the less responsive a President is to popular desires and needs, the better President he will be. It assumes that the democratic process is the obstacle to wise decisions.
- 4 The theory of American democracy is quite the opposite. It is that the give-and-take of the democratic process is the best source of wise decisions. It is that the President’s duty is not to ignore and override popular concerns but to acknowledge and heed them. It is that the President’s accountability to the popular will is the best guarantee that he will do a good job.
- 5 The one-term limitation, as Gouverneur Morris, final draftsman of the Constitution, persuaded the convention, would “destroy the great motive to good behavior,” which is the hope of re-election. A President, said Oliver Ellsworth, another Founding Father, “should be re-elected if his conduct prove worthy of it. And he will be more likely to render himself worthy of it if he be rewardable with it.”

- 6 Few things have a more tonic effect on a President's sensitivity to public needs and hopes than the desire for re-election. "A President immunized from political considerations," Clark Clifford told the Senate Judiciary Committee when it was considering the proposal some years ago, "is a President who need not listen to the people, respond to majority sentiment or pay attention to views that may be diverse, intense and perhaps at variance with his own. . . . Concern for one's own political future can be a powerful stimulus to responsible and responsive performance in office." . . .
- 7 The ban on re-election has other perverse consequences. Forbidding a President to run again, Gouverneur Morris said, is "as much as to say that we should give him the benefit of experience, and then deprive ourselves of the use of it." George Washington stoutly opposed the idea. "I can see no propriety," he wrote, "in precluding ourselves from the service of any man, who on some great emergency shall be deemed universally most capable of serving the public."
- 8 Jefferson, after initially favoring a single seven-year term, thought more carefully and changed his mind. Seven years, he concluded, were "too long to be irremovable"; "service for eight years with a power to remove at the end of the first four" was the way to do it. Woodrow Wilson agreed, observing that a six-year term is too long for a poor President and too short for a good one and that the decision belongs to the people. "By seeking to determine by fixed constitutional provision what the people are perfectly competent to determine by themselves," Wilson said in 1913, "we cast a doubt upon the whole theory of popular government."
- 9 A single six-year term would release Presidents from the test of submitting their records to the voters. It would enshrine the "President-knows-best" myth, which has already got us into sufficient trouble as a nation. It would be a mighty blow against Presidential accountability. It would be a mighty reinforcement of the imperial Presidency. It would be an impeachment of the democratic process itself. The Founding Fathers were everlastingly right when they turned down this well-intentioned but ill-considered proposal 200 years ago.

Write an essay in which you explain how Arthur Schlesinger Jr. builds an argument to persuade his audience that the presidential term should not be a single six-year term. In your essay, analyze how Schlesinger uses one or more of the features listed in the box above (or features of your own choice) to strengthen the logic and persuasiveness of his argument. Be sure that your analysis focuses on the most relevant features of the passage.

Your essay should not explain whether you agree with Schlesinger's claims, but rather explain how Schlesinger builds an argument to persuade his audience.

As you read the passage below, consider how Marilyn Johnson uses

- evidence, such as facts or examples, to support claims.
- reasoning to develop ideas and to connect claims and evidence.
- stylistic or persuasive elements, such as word choice or appeals to emotion, to add power to the ideas expressed.

**Adapted from Marilyn Johnson, “U.S. Public Libraries: We Lose Them at Our Peril.” ©2010 by Los Angeles Times. Originally published July 6, 2010.**

- 1 The U.S. is beginning an interesting experiment in democracy: We’re cutting public library funds, shrinking our public and school libraries, and in some places, shutting them altogether.
- 2 These actions have nothing to do with whether the libraries are any good or whether the staff provides useful service to the community. This country’s largest circulating library, in Queens, N.Y., was named the best system in the U.S. last year by Library Journal. Its budget is due to shrink by a third. Los Angeles libraries are being slashed, and beginning this week, the doors will be locked two days a week and at least 100 jobs cut. And until it got a six-month reprieve June 23, Siskiyou County almost became California’s only county without a public library. Such cuts and close calls are happening across the country. We won’t miss a third of our librarians and branch libraries the way we’d miss a third of our firefighters and firehouses, the rationale goes . . . but I wonder.
- 3 I’ve spent four years following librarians as they deal with the tremendous increase in information and the many ways we receive it. They’ve been adapting as capably as any profession, managing our public computers and serving growing numbers of patrons, but it seems that their work has been all but invisible to those in power. I’ve talked to librarians whose jobs have expanded with the demand for computers and training, and because so many other government services are being cut. The people left in the lurch have looked to the library, where kind, knowledgeable professionals help them navigate the government bureaucracy, apply for benefits, access social services. Public officials will tell you they love libraries and are committed to them; they just don’t believe they constitute a “core” service. . . .
- 4 The people who welcome us to the library are idealists, who believe that accurate information leads to good decisions and that exposure to the intellectual riches of civilization leads to a better world. The next Abraham Lincoln could be sitting in their library, teaching himself all he needs to know to save the country. While they help us get online, employed and informed, librarians don’t try to sell us anything. Nor do they turn around and broadcast our problems, send us spam or keep a record of our interests and needs, because no matter how savvy this profession is at navigating the online world, it clings to that old-fashioned value, privacy. (A profession dedicated to privacy in charge of our public computers? That’s brilliant.) They represent the best civic value out there, an army of resourceful workers that can help us compete in the world.

- 5 But instead of putting such conscientious, economical and service-oriented professionals to work helping us, we're handing them pink slips. The school libraries and public libraries in which we've invested decades and even centuries of resources will disappear unless we fight for them. The communities that treasure and support their libraries will have an undeniable competitive advantage. Those that don't will watch in envy as the Darien Library in Connecticut hosts networking breakfasts for its out-of-work patrons, and the tiny Gilpin County Public Library in Colorado beckons patrons with a sign that promises "Free coffee, Internet, notary, phone, smiles, restrooms and ideas."
- 6 Those lucky enough to live in those towns, or those who own computers, or have high-speed Internet service and on-call technical assistance, will not notice the effects of a diminished public library system—not at first. Whizzes who can whittle down 15 million hits on a Google search to find the useful and accurate bits of info, and those able to buy any book or article or film they want, will escape the immediate consequences of these cuts.
- 7 Those in cities that haven't preserved their libraries, those less fortunate and baffled by technology, and our children will be the first to suffer. But sooner or later, we'll all feel the loss as one of the most effective levelers of privilege and avenues of reinvention—one of the great engines of democracy—begins to disappear.

Write an essay in which you explain how Marilyn Johnson builds an argument to persuade her audience that public libraries should not lose funding. In your essay, analyze how Johnson uses one or more of the features listed in the box above (or features of your own choice) to strengthen the logic and persuasiveness of her argument. Be sure that your analysis focuses on the most relevant features of the passage.

Your essay should not explain whether you agree with Johnson's claims, but rather explain how Johnson builds an argument to persuade her audience.



KJOS	NGOS	NROS	OGOS
KWOS	NJOS	NWOS	OKOS
KXOS	NKOS	NXOS	OLOS
NBOS	NLOS	OBOS	ONOS
NCOS	NNOS	OCOS	OROS





## Answer Key – Determine Raw Scores

### Reading Test Answers

Question #	Correct Answer	Question #	Correct Answer	Question #	Correct Answer	Question #	Correct Answer
1	A	14	C	27	C	40	B
2	D	15	C	28	A	41	D
3	A	16	D	29	C	42	A
4	C	17	D	30	A	43	B
5	B	18	B	31	D	44	D
6	C	19	D	32	B	45	C
7	B	20	C	33	C	46	C
8	A	21	A	34	C	47	A
9	D	22	C	35	B	48	D
10	C	23	B	36	D	49	B
11	B	24	D	37	D	50	A
12	B	25	A	38	B	51	D
13	A	26	B	39	D	52	A

**Reading Test Raw Score**  
(Number of Correct Answers)

### Writing and Language Test Answers

Question #	Correct Answer	Question #	Correct Answer	Question #	Correct Answer	Question #	Correct Answer
1	B	12	B	23	C	34	C
2	C	13	A	24	B	35	B
3	D	14	D	25	B	36	A
4	C	15	D	26	A	37	D
5	A	16	B	27	A	38	A
6	D	17	D	28	C	39	A
7	B	18	C	29	D	40	B
8	C	19	C	30	A	41	D
9	D	20	B	31	B	42	B
10	B	21	D	32	D	43	C
11	C	22	D	33	A	44	C

**Writing and Language Test Raw Score**  
(Number of Correct Answers)

“U” indicates a question that did not perform as expected and has been removed from scoring.

On test day you may have answered questions in a different order than what you see above. Use the questions and answers online to determine specific answers.

## Answer Key – Determine Raw Scores (continued)

### Math Test – No Calculator Answers

Question #	Correct Answer	Question #	Correct Answer	Question #	Correct Answer	Question #	Correct Answer
1	B	5	C	9	C	13	D
2	D	6	B	10	C	14	A
3	B	7	A	11	B	15	B
4	A	8	B	12	A		

Question #	Correct Answer
16	2,4,8
17	2
18	6
19	1/2,.5
20	8

**Math Test – No Calculator  
Raw Score**  
(Number of Correct Answers)

### Math Test – Calculator Answers

Question #	Correct Answer	Question #	Correct Answer	Question #	Correct Answer	Question #	Correct Answer
1	A	9	C	17	C	25	C
2	C	10	C	18	B	26	D
3	A	11	B	19	B	27	A
4	D	12	B	20	A	28	A
5	B	13	B	21	A	29	D
6	B	14	C	22	B	30	D
7	A	15	A	23	C		
8	D	16	B	24	B		

Question #	Correct Answer
31	129
32	760
33	6
34	296
35	84
36	8
37	2.75,11/4
38	50

**Math Test – Calculator  
Raw Score**  
(Number of Correct Answers)

“U” indicates a question that did not perform as expected and has been removed from scoring.

On test day you may have answered questions in a different order than what you see above. Use the questions and answers online to determine specific answers.

# CONVERSION TABLES

## Raw Score Conversion – Section and Test Scores (Paper Test)

### Section and Test Scores

**RAW SCORE CONVERSION TABLE 1**

Raw Score (# of correct answers)	Math Section Score	Reading Test Score	Writing and Language Test Score
0	200	10	10
1	200	10	10
2	210	10	10
3	220	10	11
4	240	11	11
5	250	12	12
6	260	13	13
7	280	13	14
8	290	14	15
9	300	15	15
10	310	15	16
11	330	16	16
12	340	17	17
13	350	17	17
14	360	18	18
15	370	18	18
16	390	19	19
17	400	19	19
18	410	19	20
19	420	20	20
20	430	20	21
21	450	21	21
22	460	21	22
23	470	22	22
24	480	23	23
25	490	23	23
26	500	24	24
27	510	24	24
28	510	25	25
29	520	25	26

Raw Score (# of correct answers)	Math Section Score	Reading Test Score	Writing and Language Test Score
30	530	26	26
31	530	26	27
32	540	27	28
33	550	27	28
34	550	28	29
35	560	28	29
36	570	29	30
37	580	29	31
38	590	30	31
39	590	30	32
40	600	31	33
41	610	31	34
42	620	32	36
43	630	32	38
44	640	33	40
45	650	34	
46	660	34	
47	670	35	
48	680	36	
49	690	37	
50	700	38	
51	710	39	
52	720	40	
53	740		
54	750		
55	770		
56	780		
57	790		
58	800		

### Section and Test Scores

**CONVERSION EQUATION 1**

